

TRIME[®]-PICO 64/32

Manual

More Information:
www.imko.de



Moisture Sensor Experts



Thank you very much for your decision to purchase this IMKO product.

Should you have any queries please don't hesitate to contact your local distributor or address directly to IMKO.

PICO32:

The measurement solution for high quality in resolution and selective measurement tasks. For near surface Monitoring or laboratory tasks.

PICO64:

The measurement solution for heterogeneous soils and various measurement tasks. Precise measurements with a large measuring field in challenging conditions.

List of Contents

1	Functional Description	5
1.1	Operation modes	5
1.1.1	Operation mode A (Bus communication)	5
1.1.2	Operation mode B (Single measurement)	6
1.1.3	Operation mode C (Cyclic measurement)	6
1.1.4	PC connection	6
1.2	External power supply	7
1.3	Installation hints	7
2	Technical Data	8
2.1	TRIME-PICO64	8
2.2	TRIME-PICO32	8
3	TRIME-PICO64/32 Versions	10
3.1	PICO DataLogger cable 5m with end splices	11
3.2	PICO IMP-Bus cable 5m, 4-pin female connector	11
3.3	PICO BT+TRIME-HD cable 1,5m, 7-pin female connector	11
3.4	Accessories	12
3.4.1	E-Box (Extension Box)	12
3.4.2	C-Box (Current Box)	12
3.4.3	SM-USB Serial Interface Module	13
3.4.4	PICO-BT Bluetooth Module	13
3.5	Datalogging with Differential Analog Inputs	14
4	Installation details	15
4.1	Temperature measurement	15
4.2	Installation equipment	15
4.2.1	Preparation set for TRIME-PICO64	15
4.2.2	Preparation set for TRIME-PICO32	15
4.2.3	Extension tubes for TRIME-PICO64 & TRIME-PICO32	16
4.2.4	Hand Auger Set for TRIME-PICO64 & TRIME-PICO32	16
5	Remote Power Supply to TRIME-PICO	17
6	Basic Calibration with the Calibration Set	19
6.1	What is a basic calibration?	19
6.2	What are the benefits of the calibration set for the user?	19
6.3	How to perform a basic calibration?	20
6.3.1	Preparation of the glass beads	20
6.3.2	Basic calibration procedure	20
7	Material-Specific Calibration	21
8	Mounting Spare Rods with O-ring Seals	23
9	Information on Lightning Protection of the ENVIS Environmental Measurement System	24
9.1	Introduction	24
9.2	Excess voltage protection on 110/220V mains supply	24
9.3	Protection of modem and telephone lines	24
9.4	Excess voltage protection for network modules by "SM-Blitz"	24
9.5	Lightning protection on meteorological towers	24
9.6	Installation instructions for SM BLITZ lightning protection modules	25
9.7	Conclusion	25
10	Datalogging configuration examples	26
10.1	PICO probes connected to the GlobeLog data logger via the IMP-Bus	26
10.2	PICO probes connected to a PC under Windows	26
10.3	PICO probes connected to a SDI12 Datalogger	27

11	Quick guide for the Software PICO-CONFIG	28
11.1	Connection of the RS485 or the SDI-12 and the IMP-Bus to the SM-USB Module	28
11.2	RS485 or IMP-Bus Configuration and Probe Scan.....	30
11.3	Scan of connected PICO probes on the RS485 or IMP-Bus	30
11.4	Configuration of Measure Mode	31
11.5	Analogue outputs of the PICO probe.....	31
11.6	Simulate Analog Output	32
11.7	Selection of the individual Calibration Curves	32
11.8	Test Run in Measurement Mode A.....	33
11.9	TRIME WIN MONITOR Datalogger Software.....	35
11.10	Calibration Curves.....	35
11.11	Creating a linear Calibration Curve for a specific Material.....	38
11.12	Calculation for a linear 2-point calibration curve.....	38
11.13	Calculation for a non-linear calibration curve.....	39
12	Measure Electrical Conductivity with TRIME Probes	40
12.1	The analysis of Soils for Electrical Conductivity ECTRIME	41
12.2	ECTRIME Measurement Range for TRIME Probes	42
12.3	Measurement of Pore-Water-Conductivity or Salt-Content of Soils.....	42
12.4	Creation of a Moisture/ EC _{TRIME} Diagram for a particular Soil	45
13	Software Error codes	46
13.1	Software Errors which will be coded with 4 igits.	46
13.2	PICO Errors (Firmware errors). The errors come from the firmware, from 1 to 255.	47
14	Safety Notes.....	48

1 Functional Description

The intelligent and compact TRIME-PICO64/32 sensors are measurement devices for continuous and non-destructive determination of volumetric or gravimetric material moisture, material temperature and material conductivity. They are designed for stationary subterranean field use. A variety of installation options (greater depth, vertical or horizontal orientation) offer a wide range of applications.

TRIME-PICO64/32 systems require an external 7-24V/DC power supply. They are designed for connection to a data logger or a PC for monitoring and data logging purposes.

Your sensor is supplied ready for use and works in a wide range of standard soils. For further information please check the details under Section 6!

1.1 Operation modes

TRIME-PICO64/32 systems are supplied with an IMP-Bus interface **and** analogue output of 0..1V for soil moisture and temperature.

TRIME-PICO64/32 sensors can be easily connected (in operation modes A) to SDI12 datalogger **and** conventional analogue data loggers (in operation modes B and C).

A detailed description of how to select a specific operation mode for your application can be found below.

NOTE:

Analogue dataloggers require differential inputs!

1.1.1 Operation mode A (Bus communication)

TRIME-PICO64/32 systems can be connected directly to the IMP-Bus (4-wire bus system), either via SDI12 datalogger or via the SM-23U level converter module for use in conjunction with the EnvisLog data-logging software.

If multiple sensors are to be wired as a network, IMKO offers 3-port, 6-port and 12-port distribution modules. Please note that the IMP-Bus cable length and cable diameter must be properly matched as otherwise the energy consumption of the TRIME sensors (100mA @ 12V/DC for 2..3s) may cause a drop in voltage. *More information is available in Section 5.*

► Benefits:

- Low power consumption in field installations (with SDI12 datalogger)
- Straightforward installation and simple wiring by virtue of pre-configured standard components (e.g. lightning protection, distribution modules...)
- Attachment of any other analogue sensors to IMP-Bus (via SM-Modules)
- Systems are supplied ready for use
- Cable length >1000m (with only 4 wires for all sensors)

► For use with:

- SDI12 Datalogger
- EnvisLog (PC-Software for Microsoft Windows) only with converter module SM-USB
- IMKO calibration and test software PICO-CONFIG (see page 27, Software download: www.imko.de) only with converter module SM-USB

1.1.2 Operation mode B (Single measurement)

TRIME-PICO64/32 will perform a single measurement when the power is switched on. Once the measurement has been taken (2..3s) the readings are supplied as analogue output signals until the power is switched off. The probe switches to the energy-saving mode (>1mA) and takes no more measurements until the power has been switched off.

▶ Benefits:

- Low power consumption in field installations
- Easy control of the measurement rate from an external source
- No implementation of commands necessary

▶ For use with:

- Switched power supply
- Analogue data loggers with relay
- PC A/D converter boards with relay

1.1.3 Operation mode C (Cyclic measurement)

TRIME-PICO64/32 takes measurements at a freely configurable measurement rate (from 8s..24h). Once the measurements have been taken (2..3s) the measured values are supplied as analogue output signals. Until the next measurement is finished, the values of the previous measurement are available as analogue signal.

In standby until the next measurement is executed the probe consumes 8..10mA @ 12V/DC, if the communication is set to standby (can be changed in PICO-CONFIG software) 2..3mA @ 12V/DC.

▶ Benefits:

- Probe can be supplied with mains power
- Measurement rate can be specified as required (even independent from logging rate of analogue logger)
- No implementation of commands necessary
- Non-intelligent logger can be used (without power management)

▶ For use with:

- Mains power
- Analogue data loggers with mains power
- PC A/D converter boards

The operation mode is preset to customer specifications prior to despatch. Reconfiguration is possible using the complementary software PICO-CONFIG (download under <http://www.imko.de>).

1.1.4 PC connection

The TRIME-PICO64/32 can be connected to a PC via:

- ▶ SM-23U IMP-Bus → RS232 converter module
- ▶ BT-Module RS485 → Bluetooth converter module
- ▶ SM-USB IMP-Bus/RS485 → USB converter module

1.2 External power supply

In the IMP-Bus the power to sensors can be supplied by battery, a complete solar system or mains power. For serial connection of a large number of sensors or long IMP232-bus cables it is advisable to use a power amplifier module (SM-23LV) or decentralised power supply.

1.3 Installation hints

Please assure careful installation of the probes with close contact between rod and soil. It is important to avoid air pockets around the rods as the highest measuring sensitivity is directly around them.

Air pockets around the probe rods can reduce the measured moisture reading. Where saturated soils are involved, water-filled air pockets will result in an exaggerated reading.

IMKO supplies pre-drilling sets for an optimal preparation of the installation point avoiding compaction of soil otherwise caused by the insertion of the rods.

2 Technical Data

2.1 TRIME-PICO64

For in situ monitoring of volumetric moisture in soils. The large measuring volume is particularly suitable for applications in heterogeneous and skeletal media. Burying capability for both horizontal and vertical orientation.

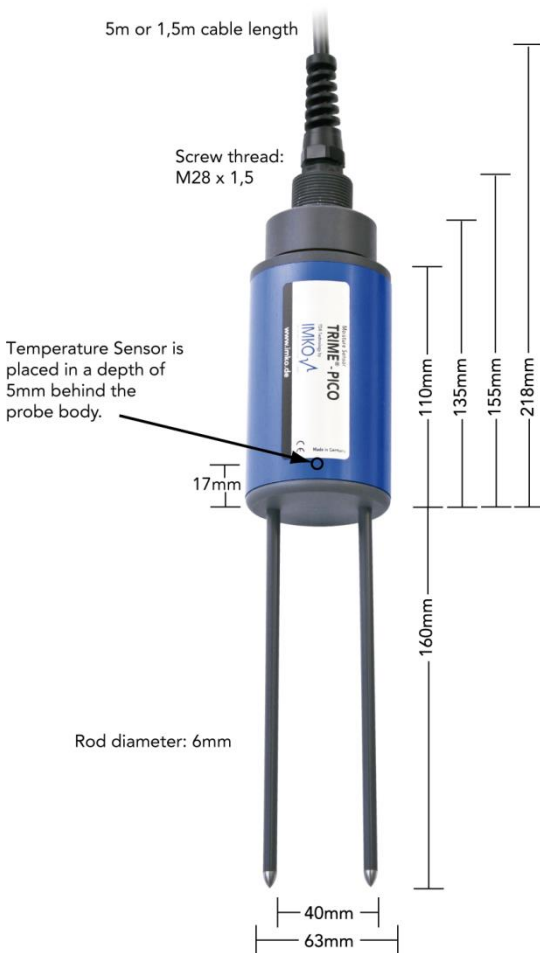

2.2 TRIME-PICO32

For in situ monitoring of volumetric moisture in soils. The small measuring volume permits high spatial resolution. Burying capability for both horizontal and vertical orientation.

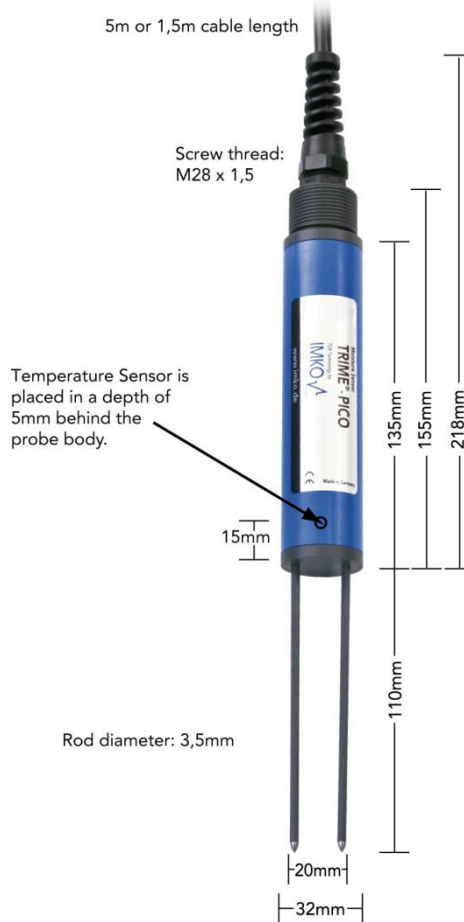

Technical Data



TRIME®-PICO64



TRIME®-PICO32

Power supply:	7V, 24V-DC					
Power consumption:	100mA @ 12V/DC during 2.3sec. of measuring					
Moisture measuring range:	0..100% volumetric water content					
Accuracy (in % volumetric water content):						
Conductivity range:	0..6dS/m	6..20dS/m	>20dS/m	0..6dS/m	6..20dS/m	>20dS/m
Moisture range 0..40%:	±1%	±2%	with material specific calibration	±1%	±2%	with material specific calibration
Moisture range 40..70%:	±2%	±3%		±2%	±3%	
Repeating accuracy:	±0.2%	±0.3%		±0.2%	±0.3%	
Temperature caused drift of electronics (full range):	±0.3%					
Soil temperature measuring range:	-15°C...50°C					
Soil temperature measuring accuracy:	±1,5°C absolute; ±0,5°C relative					
Measurement volume:	1,25L ± 160x100mm diameter			0,25L ± 110x50mm diameter		
Operating Temperature:	-15°C...50°C (extended temperature range on request)					
Calibration:	Calibration for a wide range of standard soil types (in accordance with Topp (equation))					
	standard calibration for most soils, customizable material specific calibration, storage of up to 15 user defined calibration curves, calibration of dielectric permittivity is possible			standard calibration for most soils, customizable material specific calibration, storage of up to 15 user defined calibration curves, calibration of dielectric permittivity is available		
Probe body:	waterproof sealed PVC (IP68)					
Size:	155 x Ø63mm			155 x Ø32mm		

Options	Interfaces	Application	Cable length	Connector
Option 1:	RS485 & analogue	mobile for HD2 and PICO-BT	1,5 m	7-pin female
Option 2:	IMP-BUS	for globeLog datalogger	5 m (special length on request)	4-pin female
Option 3:	RS485, IMP-BUS & analogue	for analogue datalogger Optional: E-BOX (cable extension box) Optional available for cable extension and current output: C-BOX (0..1V to 0(4)..20 mA converter box)	5 m (special length on request)	10-pin end splices
Option 4:	SDI-12, IMP-BUS & analogue	for SDI-12 datalogger	5 m (special length on request)	9-pin end splices

3 TRIME-PICO64/32 Versions

Option1: RS485 interface, (analogue outputs)



alternative to the HD2:
PICO-BT Bluetooth and PDA



Option2: IMP-Bus

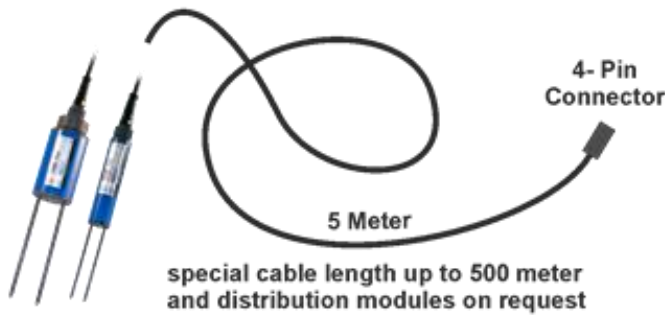

IMKO's GlobeLog Datalogger



Option3: Analogue outputs, RS485 and IMP-Bus

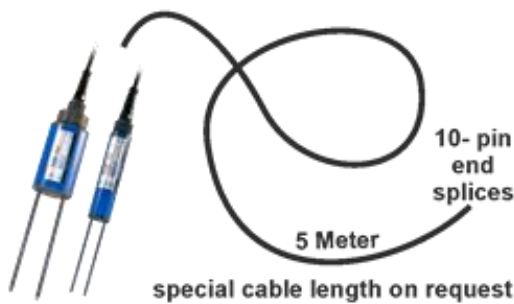

C-Box Optional accessory for PICO32/64 and very long cable lengths. Voltage / Current converter for PICO probes from 0..1V voltage output to current 0(4)..20mA.

External Datalogger with serial interface RS485 or analogue inputs

Option4: Analogue outputs, SDI12 and IMP-Bus

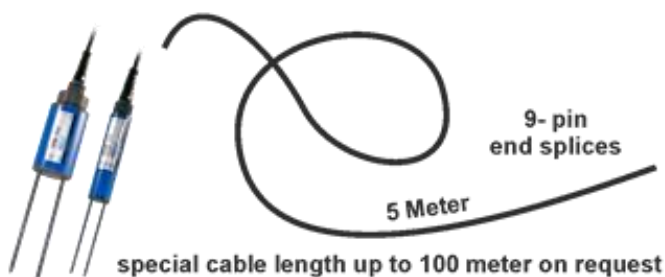

SDI12 Data-logger

or

SM-USB



Connection to the USB-Port. The SM-USB works with costfree data-logger software TRIME WinMonitor under Windows.

3.1 PICO DataLogger cable 5m with end splices

Wiring:	
Pink:	Shield
Grey:	0..1V = -40..+70°C soil temperature
Violet:	AGND
White:	0..1V = 0..100% vol. water content
Blue:	COM (IMP-Bus)
Green:	R/T (IMP-Bus)
Black:	GND; (SDI-12 GND)
Red:	+Vs; (SDI-12 +Vs)
Yellow:	RS485B; (SDI-12 Data if SDI-12 version)
Brown:	RS485A

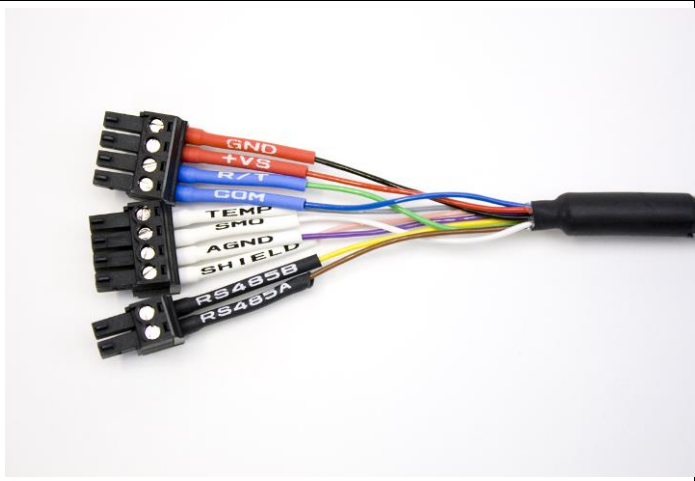

3.2 PICO IMP-Bus cable 5m, 4-pin female connector

Pin layout:	
Pin 1:	+Vs
Pin 2:	R/T (IMP-Bus)
Pin 3:	GND
Pin 4:	COM (IMP-Bus)

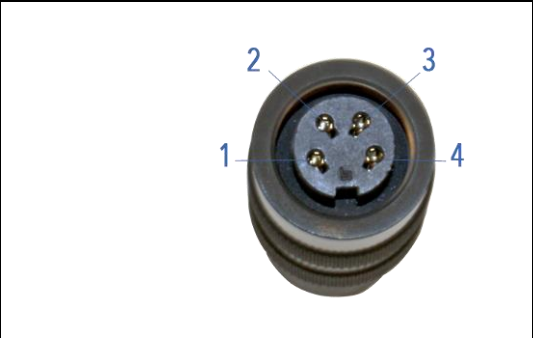

3.3 PICO BT+TRIME-HD cable 1,5m, 7-pin female connector

Pin layout:	
Pin 1:	+Vs
Pin 2:	RS485-B
Pin 3:	GND
Pin 4:	RS485-A
Pin 5:	0..1V = 0..100% vol. soil water content
Pin 6:	AGND
Pin 7:	0..1V = -40..+70°C soil temperature

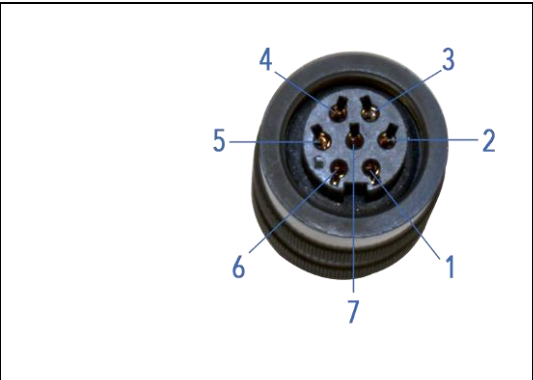

List of abbreviations:	
+Vs: + Voltage supply (7..24V/DC)	COM: Common (ground for IMP-Bus)
GND: Ground (for voltage supply)	AGND: Analogue ground
R/T: Receive/Transmit (on IMP-Bus)	

3.4 Accessories

3.4.1 E-Box (Extension Box)

For extending the cable length of the TRIME-PICO with DataLogger cable (see 3.1) up to 35m with 0..1V output signal.



3.4.2 C-Box (Current Box)

For extending the cable length of the TRIME-PICO with DataLogger cable (see 3.1) and converting the 0..1V signal into 0(4)..20mA (cable length >100m possible).

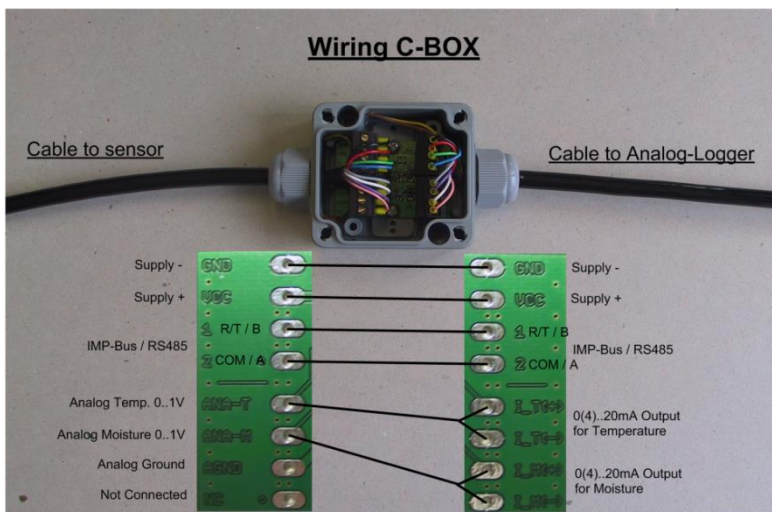

3.4.3 SM-USB Serial Interface Module

For connecting any of the TRIME-PICO (see 3.1 to 3.3, for 3.2 & 3.3 adapter required) via the USB-Interface to a PC. The module offers 2 Sensor-Interfaces, IMP-Bus (IMKO specific) and RS485 (industrial standard). One sensor can be powered out of the USB-Interface, if multiple sensors are connected external power supply is required!

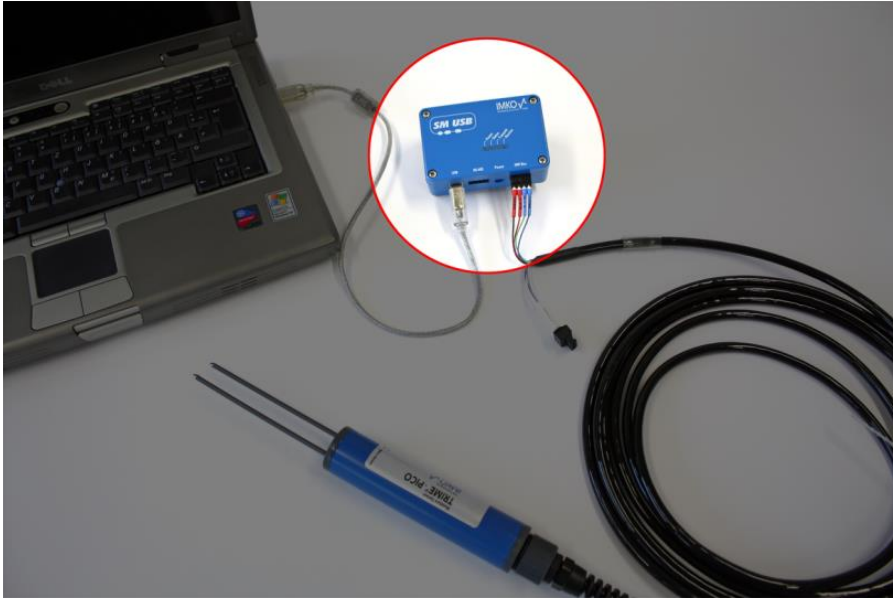

3.4.4 PICO-BT Bluetooth Module

For connecting the TRIME-PICO with PICO BT+TRIME-HD cable (see 3.3) to a Android Smartphone/PC via Bluetooth interface. Module contains an internal rechargeable battery, which enables >1000 measurements.



3.5 Datalogging with Differential Analog Inputs

Using a datalogger with a common ground will produce considerable problems, due to earth loops. The higher the length of the cable the higher the problems with earth loops. Earth loops can produce considerable fluctuations at the measurement signal 0 to 1V !

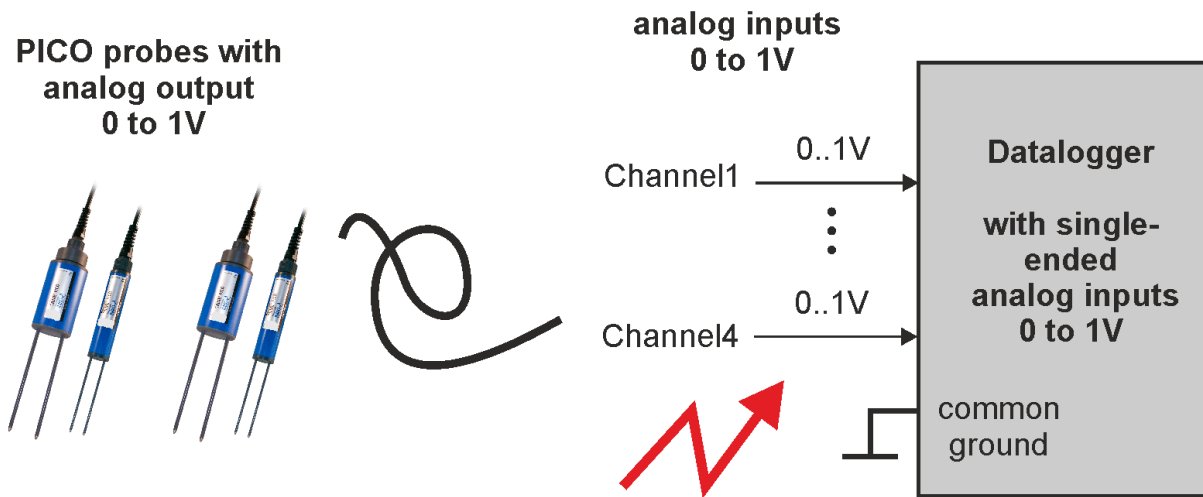

IMKO recommends to use a datalogger with differential inputs as shown in the following picture. With differential inputs the problems with earth loops are eliminated.

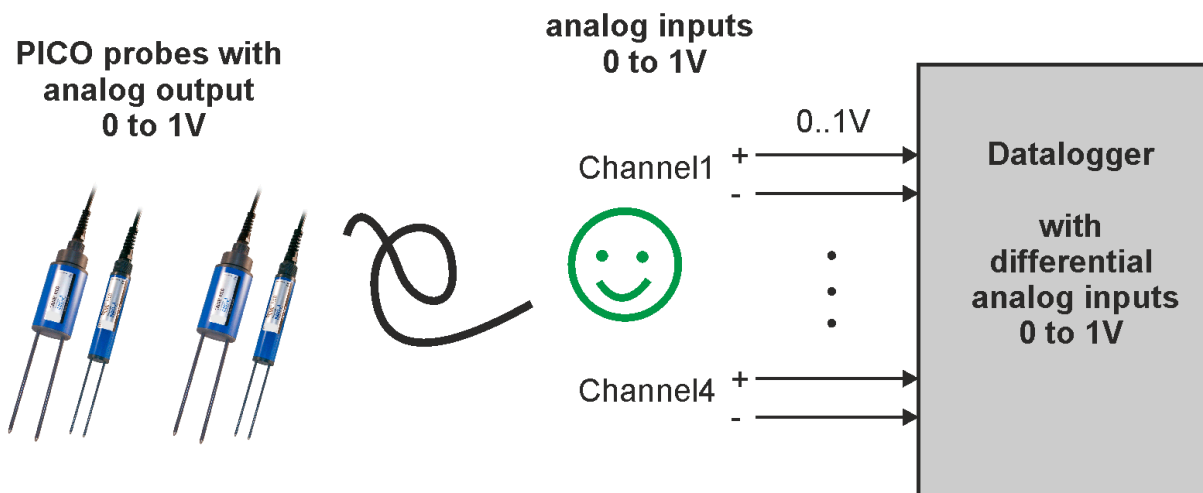

4 Installation details

4.1 Temperature measurement

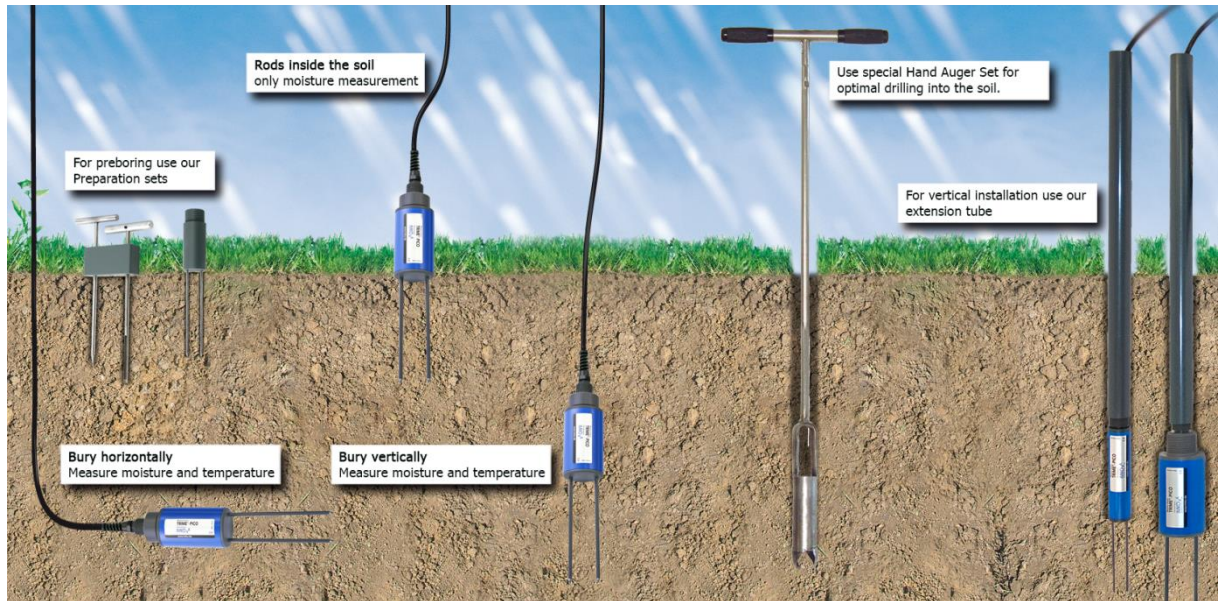

Conclusion: the probes should be permanently buried in the soil for optimum temperature measurement!

4.2 Installation equipment

4.2.1 Preparation set for TRIME-PICO64

For preboring the soil prior to probe insertion.

- 1 x spike
- 1 x core drill
- 1 x PVC block

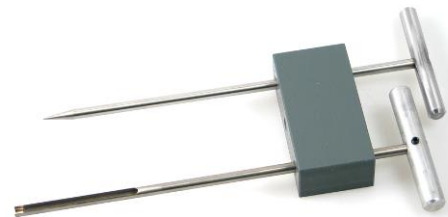

4.2.2 Preparation set for TRIME-PICO32

For preboring the soil prior to probe insertion.
Rod length: 110mm.

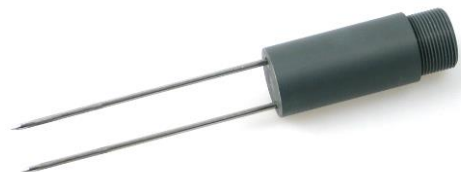

For compacted, coarse or stony soil use the preparation set to bore a pilot hole!

Preboring using the preparation rods for PICO32 and PICO64 avoids

- ▶ compaction of soil (which would impair measurement accuracy)
- ▶ damaging the probe's rods or rod tips. A defective PVC rod coating or a blank rod is sensitive to electromagnetic charge and may destroy the electronics of sensor.

4.2.3 Extension tubes for TRIME-PICO64 & TRIME-PICO32

Length 0.5m

Length 1.0m



4.2.4 Hand Auger Set for TRIME-PICO64 & TRIME-PICO32

Please contact us for further details.

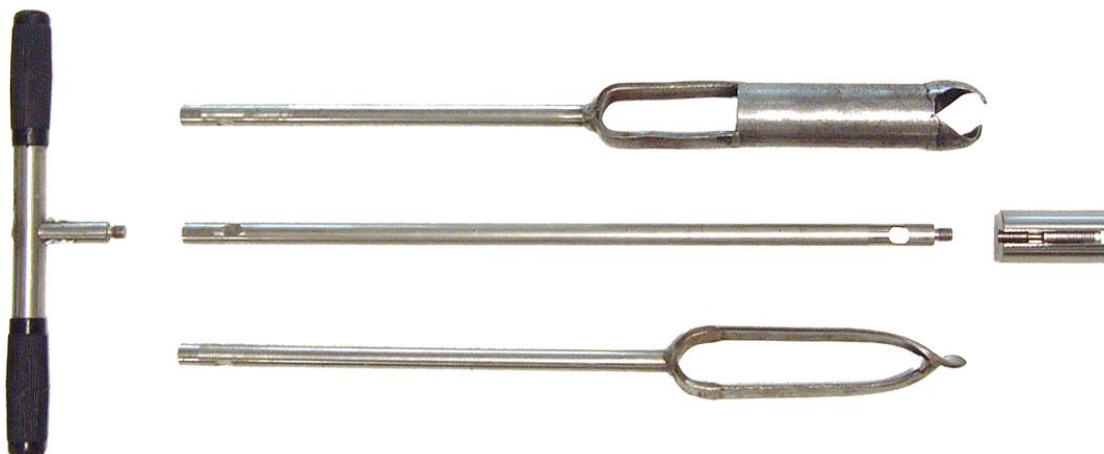

5 Remote Power Supply to TRIME-PICO

The operation of TRIME sensors may cause problems when power has to be supplied via long cables. There are limitations to the maximum cable length depending on the cable diameter.

When power is supplied over long distance the maximum cable length depends on the cable cross section A , the supply voltage V_s and the number n of the sensors measuring simultaneously. Device-specific data also be applied to the formula:

Power consumption during measurements:	I_{norm}	=	100mA@ 12V/DC
Power consumption at min. voltage:	I_{max}	=	175mA@ 7V/DC
Supply voltage:	V_s	=	12V
Minimum sensor voltage at circuit end:	V_{min}	=	7V
Wire cross section:	A	=	0,34mm ²
Specific electrical resistance of copper:	ρ	=	0.0178Ω x mm ² / m
Number of sensors:	n	=	1...

The maximum possible circuit length l_{max} can then be calculated in the following manner:

$$l_{\text{max}} = \frac{A \cdot (V_s - V_{\text{min}})}{2 \cdot \rho \cdot n \cdot I_{\text{max}}}$$

Please see the following the following example:

In the IMP232 environmental measurement system a bus cable with a wire cross section of $A = 0.34 \text{ mm}^2$ is normally used. We further assume that the power supply voltage is $V_s = 12 \text{ V}$ and only one sensor is designated to measure. Thus $n = 1$.

$$l_{\text{max}} = \frac{0.34 \text{ mm}^2 \cdot (12 \text{ V} - 7 \text{ V})}{0.0356 \Omega \frac{\text{mm}^2}{\text{m}} \cdot 1 \cdot 0.175 \text{ A}} = 270 \text{ m}$$

In the above calculation, no tolerance is included; for security reasons the calculated cable length should be reduced by 10% to obtain a realistic value. In order to increase the maximum possible cable length several solutions are feasible.

1. Using cables with larger conductor diameters
By using 6-core conductor cables instead of 4-core, the cable length can be doubled as two extra cores can be used for power supply. Cables with conductors of larger diameters will further increase the maximum cable length possible.
2. Increasing the power supply voltage
Power supply voltage can be increased up to 17V, thereby raising the maximum length from 270m to 540m in the example calculation above.
3. Installation of buffer batteries in the distributor
Additional storage batteries close to the TRIME sensors, e.g. in the distributor, allow cable lengths up to 1km and enable simultaneous measurement of several sensors. However, this method requires an additional charging circuit for the buffer storage battery.
4. Installation of a voltage regulator at the distributor
Voltage loss in the cable can be reduced with a 30V power supply and an installation of a voltage regulator directly in front of the TRIME sensor, thus allowing circuit lengths of up to 1km.

Which solution is best suited mainly depends on the nature of the power supply of the measurement system:

▶ **Battery supply:**

Solution 1 and possibly solution 3 should be considered, the latter being relatively expensive.

▶ **Mains supply:**

Solutions 1 and 2 could be combined, or, more expensive, solutions 2 or 4 could be chosen.

6 Basic Calibration with the Calibration Set

6.1 What is a basic calibration?

Basic calibration serves to compensate the cable length and tolerances of the probe mechanics (thickness of the rod coating, rod length, etc.). After two measurements, one in dry and one in water-saturated glass beads, the calibration data is calculated and stored in the TRIME sensor.

Every TRIME-PICO64/32 sensor must be calibrated before it can supply proper measurement results. **Basic calibration is carried out by IMKO in the factory prior to shipment.**

6.2 What are the benefits of the calibration set for the user?

With the calibration set you can easily carry out basic calibration of your TRIME sensor yourself.

- ▶ If defective probe rods must be changed, you can perform the required basic calibration yourself.

The calibration set **cannot** be used for establishing a material (soil) specific calibration. For this purpose a measurement dataset must be created for the specific material. The complementary calibration program **TRIME-Tool** is required to calculate the calibration data for this dataset and to download it to the TRIME-PICO-Probe.

Calibration set for TRIME probes

For basic calibration of TRIME probes.

- 2 x boxes (7 litres.)
- 28kg glass beads



6.3 How to perform a basic calibration?

6.3.1 Preparation of the glass beads

The glass beads, supplied with the calibration set, have to be prepared first:

Fill up one bucket until the rods of the probe can be immersed completely. To obtain a consistent density, knock the bucket on the ground several times.

- ▶ The density of the glass beads increases with frequent insertion of probes. Therefore, the glass beads should be poured out into another bucket and poured back to achieve the original density.

Now the second bucket has to be filled with water in order to be able to fill in the glass beads without leaving air-bubbles. An additional precaution against air-bubbles is to stir slightly while filling in the glass beads. The container must now be knocked on the ground several times to obtain a consistent density. The surplus water must be poured out until the depth of the water film above the glass beads is less than 2mm.

The water-saturated glass beads should be in a temperature range between 20°C and 25°.

Attention:

Water dissolves Na_2O and K_2O from glass which causes a rising pH-value and higher electrical conductivity. New glass beads have to be washed intensively with tap water!!!

1. Fill a bucket with water
2. Stir the beads under water to drive out all air bubbles
3. Pour out the water. This procedure should be done with new glass beads at least five times, each time with fresh water. If the glass beads have been in use for a prolonged period, three times is sufficient.

NOTE:

That the electrical conductivity of the water-saturated glass beads medium increases already after a few days storage. Therefore the glass beads must be washed again before the next calibration.

6.3.2 Basic calibration procedure

Basic calibration must be performed using the calibration program *Pico-Config*. Please read the information about basic calibration with *Pico-Config* in **chapter 12** of this document.

7 Material-Specific Calibration

Your TRIME measuring system operates with a universal calibration for mineral soils as a standard. The following parameters limit the application range of the universal calibration:

- Clay content: >50%
- Organic content: >10%
- Bulk density: <1.1kg/dm³ or >1.7kg/dm³

Exceeding these limits may cause the tolerances given on page 5 to be overstepped.

Material-specific calibration is advisable if your soil is listed above or if you require accuracy down to the last digit. The **PICO-CONFIG** software is required for setting up a material-specific calibration (*download under www.imko.de*).

A test series with reference values is necessary for performing material-specific calibration (e.g. *Oven drying at 105°C until weight is constant*). The test series –and consequently the calibration– should include minimum and maximum moisture values. TRIME readings and reference values are compared in a table. The calibration coefficients must then be calculated and uploaded to the TRIME-device.

Soil Density Correction with PICO Sensors

One of the most important advantages of PICO sensors is, that it is possible to measure volumetric moisture for all soil types with <50% clay and <10% organic with just one calibration. The only factor is the offset caused by the differing soil density, which can be compensated by a formula which IM-KO offers at its homepage in an Excel-File “Soil Density Correction”.

Volcanic soils have normally lower densities, clayey soils can have higher densities. It is possible to make an offset correction with Excel functions after datalogging of the stored moisture values. But it is also possible to change the offset calibration parameter m_0 inside the PICO probe before installation and use of the PICO sensor. With help of the software tool PICO-CONFIG it is possible to load the “**Universal Soil**” calibration curve of the PICO sensor, to change it and store it back to the sensor.

Necessary is to change the parameter m_0 of the “Universal Soil” calibration curve inside the PICO probe. If a soil has a lower density as 1,4 than the PICO sensor measures a too low moisture value and therefore the calibration parameter m_0 has to be increased with an offset correction value.

E.g. if the soil density is 1,3 than the calibration parameter m_0 has to be increased with +1,21.

If e.g. the calibration parameter $m_0 = -30$ inside the PICO sensor than it has to be increased to $m_0 = -30 + 1,21 = -28,79$

If the soil has a density higher than 1,4 than the calibration parameter m_0 of the “**Universal Soil**” calibration curve has to be decreased with the appropriate offset correction value.



The correction values for some soil density values are outlined below:

	Soil Density	Factor		Error in % due to deviating Density	m0 Offset Correction Value
-0,3	1,10675	12,12	-17,05	-3,64	+3,64
-0,2	1,20675	12,12	-17,05	-2,42	+2,42
-0,1	1,30675	12,12	-17,05	-1,21	+1,21
0	1,40675	12,12	-17,05	0,00	DEFAULT
0,1	1,50675	12,12	-17,05	1,21	-1,21
0,2	1,60675	12,12	-17,05	2,42	-2,42
0,3	1,70675	12,12	-17,05	3,64	-3,64
0,5	1,90675	12,12	-17,05	6,06	-6,06
0,6	2,00675	12,12	-17,05	7,27	-7,27
0,7	2,10675	12,12	-17,05	8,48	-8,48

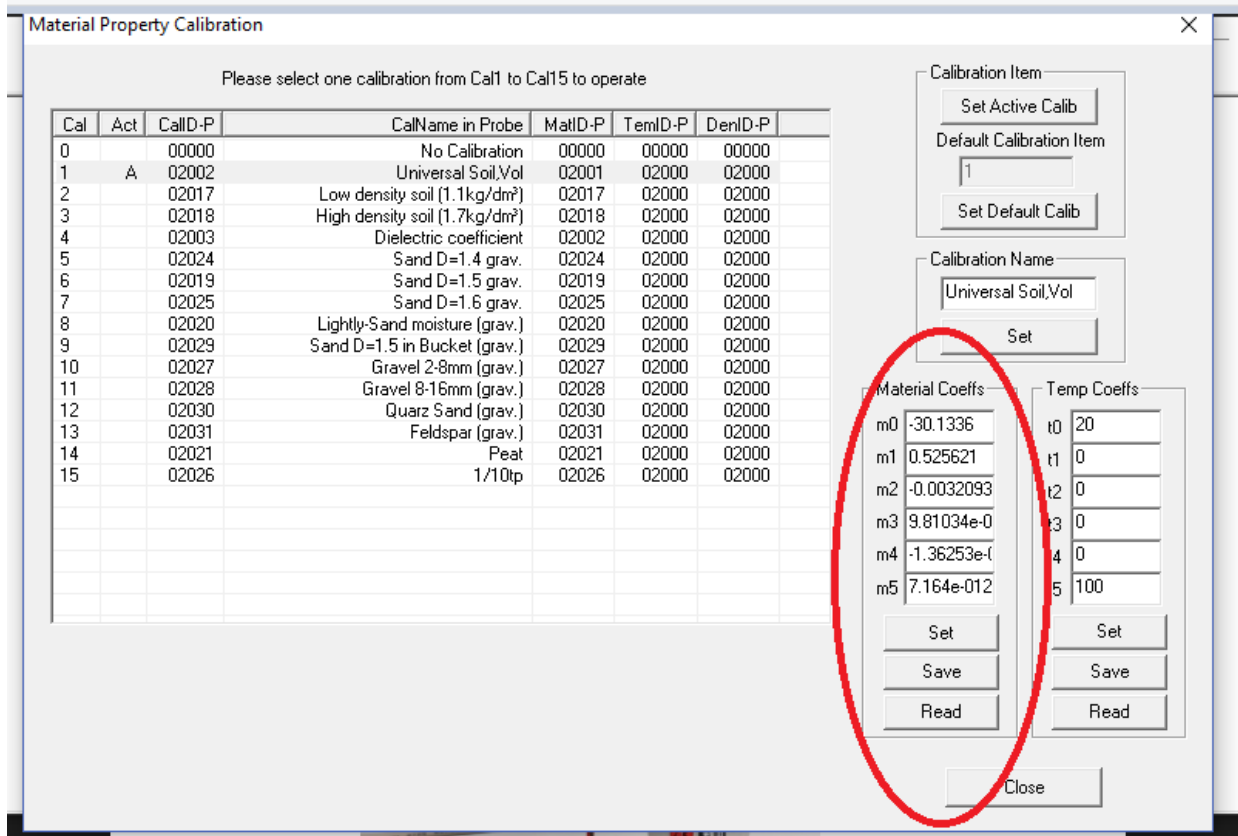
Load the Excel-file “Soil Density Correction” from IMKO’s homepage “Support” and “PICO-CON-FIG” and enter your soil density for getting the appropriate offset correction value.

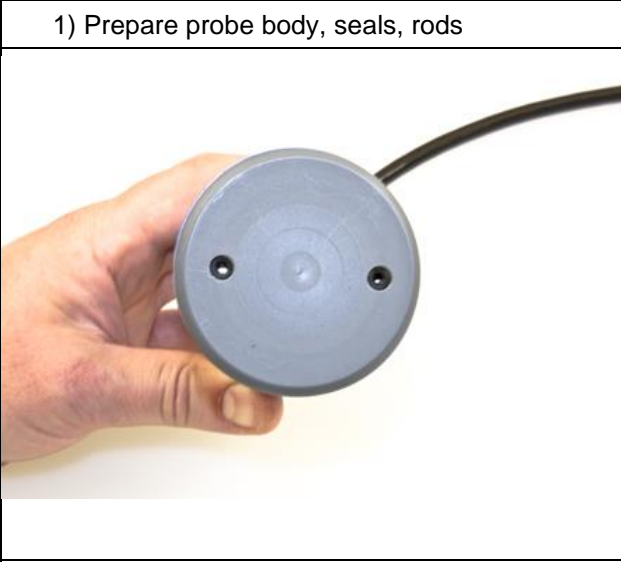
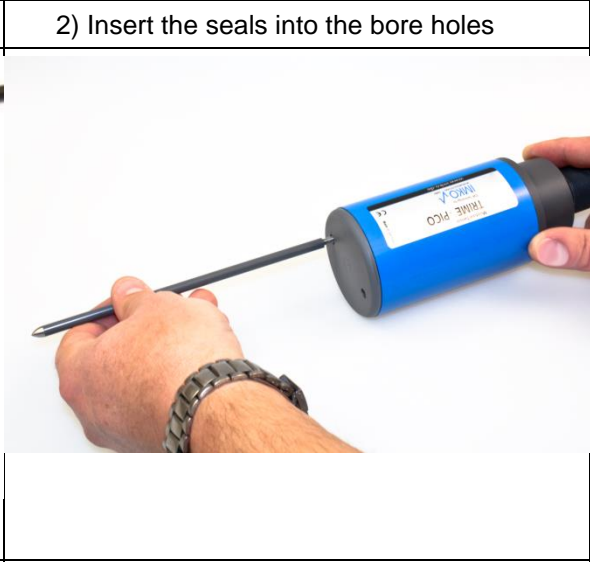

8 Mounting Spare Rods with O-ring Seals

 A blue probe body with a black cable is shown next to two long, thin metal rods and two small circular O-ring seals.	 A hand is shown pointing at the blue probe body, which has two small circular holes on its side.
1) Prepare probe body, seals, rods	2) Insert the seals into the bore holes
 A hand is shown holding a grey circular cap with two small holes, which is being pushed onto the blue probe body.	 A hand is shown using a screwdriver to screw a metal rod into the blue probe body.
3) Push the seals to the base of the bore holes where the threads begin	4) Screw the rods into the probe body

NOTE:

Basic calibration must be performed after exchanging the rods.
Failure to do so will cause a deviation of +2% or more!

9 Information on Lightning Protection of the ENVIS Environmental Measurement System

(IMP-Bus, Datalogger and integrated Sensors)

9.1 Introduction

Lightning strikes can cause considerable and costly damage to unprotected electronics. The equipment is often totally destroyed. A good number of users are not or only partially insured. Customers who have lightning protection insurance must comply with defined clauses regarding lightning and excess voltage. Insurance companies only cover the damage when compliance with the defined clauses has been proven.

IMKO strongly recommends adequate lightning / excess voltage protection equipment for ENVIS environmental measurement systems.

9.2 Excess voltage protection on 110/220V mains supply

Lightning strikes in proximity to high-voltage transmission lines can cause excess voltage in the mains power supply which may result in damage of electronic components. Environmental measurement systems with 110/220V mains supply are at risk from this excess voltage. It may affect the whole system through the power supply unit and the SDI12 datalogger or SM-23U).

Excess voltage can even enter the measuring system through the data acquisition computer's mains power supply. An excess voltage protection is highly recommended for all 110/220V devices connected to the ENVIS system

9.3 Protection of modem and telephone lines

Telephone lines are at risk from excess voltage. If a modem is connected to the measurement system the telephone line should also be protected by a lightning protection module.

9.4 Excess voltage protection for network modules by "SM-Blitz"

Excess voltage caused by lightning strokes in close proximity to the environmental measurement test system may enter the IMP-Bus transmission lines. Longer lines increase the risk of lightning strikes. Theoretically maximum protection is achieved by installation of a lightning protection module (SM-Blitz) in front of each SM-Module.

Lightning protection is not cheap but it is certainly worthwhile. A compromise should be found between costs and the maximum-affordable protection, i.e. interconnection of adjacent SM-Modules to lightning protected groups.

9.5 Lightning protection on meteorological towers

SM-Modules installed on meteorological towers cannot be protected from lightning strikes. The field strength resulting from the electromagnetic fields and the associated accumulated energy will cause damage to the electronics. Two solutions to the problem:

- ▶ Erect a higher lightning conductor close to the meteorological tower serving as a lightning conductor.
- ▶ Install the measuring modules a number of metres away. Then all lines coming from the tower have to be protected by lightning protection modules.

9.6 Installation instructions for SM BLITZ lightning protection modules

Basically, there are two potential sources of risk in the field of environmental measurement technology: transmission lines and sensors or network devices. Lightning protection modules should always be installed at the beginning and at the end of a circuit in order to protect the electronics from excess voltage (Attention: SM-Blitz modules have a protected and an unprotected side).

The SM-BLITZ lightning protection module has to be grounded using a ground conductor with a wire cross-section of at least 6 mm² screwed to the long side of the module. A 2-metre long grounding rod may serve as a ground conductor. Grounding is optimal when the grounding rod is in direct contact with ground water.

9.7 Conclusion

Only limited protection against excess voltage is possible where natural phenomenon such as lightning strikes are concerned. Direct lightning strikes may cause damage nevertheless.

10 Datalogging configuration examples

PICO probes offer the possibility to use three different options for serial communication:

- The robust and secure (opto-isolated) IMP-Bus for large area monitoring networks with cable length >500 meter,
- the RS485 as an international standard serial interface for connection of PICO probes to standard PC's, PDA's and other computers,
- or the SDI12 interface for direct connection to SDI12 dataloggers.

10.1 PICO probes connected to the GlobeLog data logger via the IMP-Bus

With IMKO's small software package TRIME WIN-MONITOR (cost free) it is possible to collect measurement data from up to 60 PICO probes to a PC. TRIME WIN-MONITOR runs under Windows.

With the software PICO-CONFIG it is possible to configurate single PICO probes, e.g. to select a special calibration curve inside the PICO probe. The connection to the PC can be configured via the module SM-USB and a USB-port to the PC.



Up to 48 TRIME® PICO probes are connectable

- Large area monitoring with cable length up to 500 meter
- via IMKO's robust and secure IMP-Bus
- 2 MByte data storage capacity
- Data transfer via cellular radio
- Robust, lightweight, weatherproof (IP67)
- Easy programming
- Low Power
- Distribution modules with 3, 6 or 12 connectors

10.2 PICO probes connected to a PC under Windows

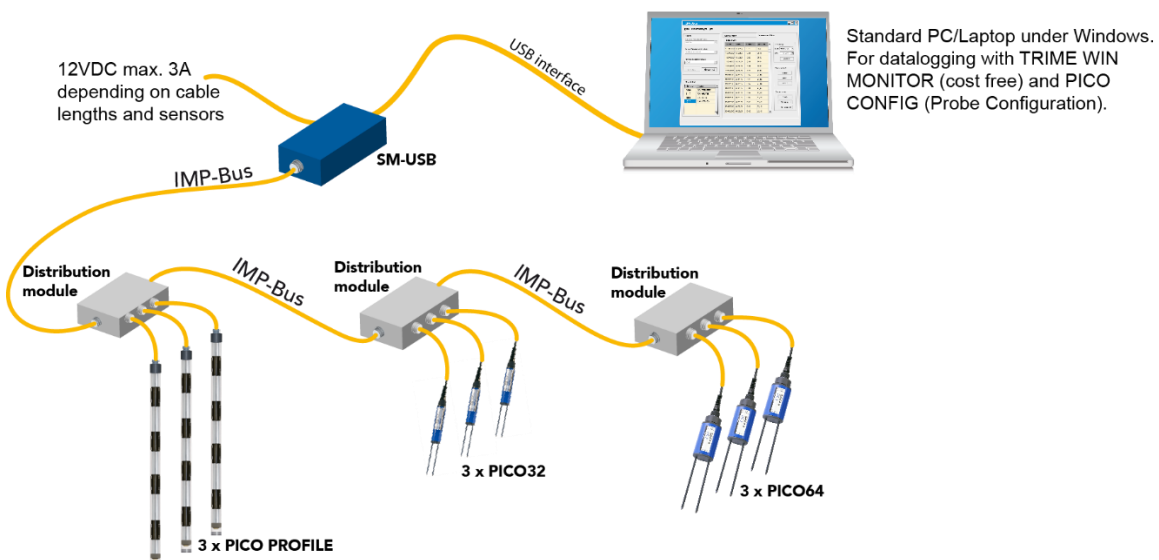

10.3 PICO probes connected to a SDI12 Datalogger

SDI12 Network Expansion for PICO Sensors

The diagram illustrates a network expansion setup. On the left, an 'IMP-Bus Network' is shown with several sensors connected: PICO 64, PICO 32, PICO PROFILE, and PICO soil moisture sensors. A dashed line separates this from the right side, which shows an 'SDI12 Slave Module' connected to the bus. This slave module is connected to an 'SDI12 Master Module'. The master module is connected to an 'SDI12-Datalogger, from Datalogger, Campbell and others'. The datalogger is powered by a 'switched Power Supply' and has a display showing 'DT20E restarted Power Loss'. The datalogger is also connected to 'Standard SDI12-Sensors' via a cable labeled 'max. 10 Meter'. The master module is connected to the datalogger via 'SDI12-Signal' and 'Power +VDC' lines.

IMKO
MICROMODULETECHNIK / GMBH

- Up to 62 PICO soil moisture sensors can be connected to only one SDI12-port at the datalogger.
- Up to 1 km cable length! Optional SDI12- Slave Module for the connection of standard SDI12- sensors on site.
- Simple cables can be used in topologies of ring, star and their combinations.
- Safe data transmission due to galvanic signal isolation and therefore no problems with signal disturbances or ground loops!

The advantages of the SDI12 interface:

- Easy and uncomplicated connectivity of sensors, directly in physical units. Without elaborate and susceptible analogue signals.
- Only two signal lines for connection of up to 62 sensors.
- Large choice of SDI12 sensors from various sensor manufacturers.

But in practice the SDI12 interface can cause significant problems:

- ⚡ Limitation of the number of sensors due to too weak SDI12 signal levels.
- ⚡ Limitation of the cable length to only 10 meter, dependent on topology.
- ⚡ Low noise immunity of the SDI12 signal.

11 Quick guide for the Software PICO-CONFIG

11.1 Connection of the RS485 or the SDI-12 and the IMP-Bus to the SM-USB Module

The SM-USB is available in two versions, for the RS485 or optionally for the SDI-12 interface (but not together!). The SM-USB provides the ability to connect a PICO probe either to the standard RS485 interface (in special version the SDI-12) and to the IMP-Bus from IMKO, which enables the download of a new firmware to the PICO probe.

Both connector ports are shown in the drawing below. The SM-USB is signalling the status of power supply and the transmission signals with 4 LED's. When using a dual-USB connector on the PC, it is possible to use the power supply for the PICO probe directly from the USB port of the PC without the use of the external AC adapter.

Connection to the Probe:

RS485 or SDI-12 Connector

0V GND
+Vs
RS485B or SDI-12 Data
RS485A (not used for SDI-12)

IMP-Bus Connector

With the option to accomplish a download of the firmware for the PICO probe

0V GND
+Vs
R/T IMP-Bus
COM IMP-Bus

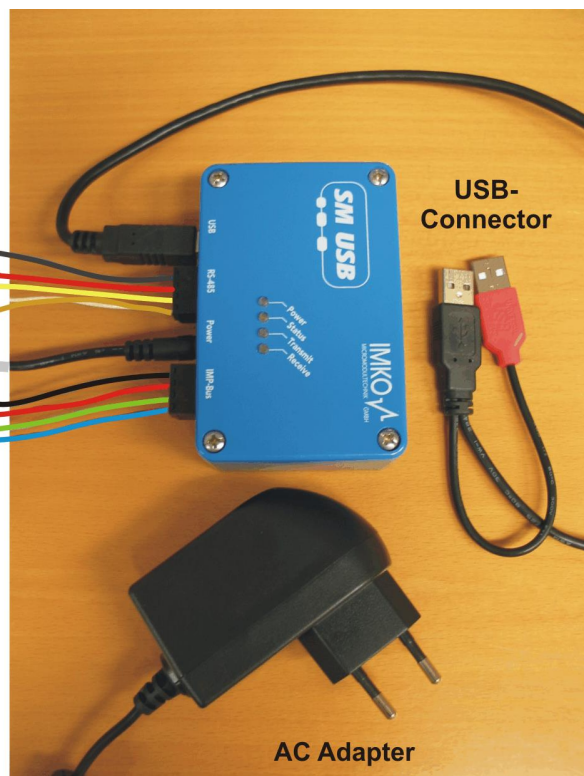

How to start with the USB-Module SM-USB from IMKO

- Install USB-Driver from USB-Stick.
- Connect the SM-USB to the USB-Port of the PC and the installation will be accomplished automatically.
- Install Software **PICOConfig-SetUp.msi** from USB-Stick.
- Connection of the PICO probe to the EX9531 via RS485A, RS485B and 0V.
- Check the setting of the COM-Ports in the Device-Manager und setup the specific COM-Port with the Baudrate of 9600 Baud in PICO-CONFIG with the button "**Bus**" and "**Configuration**" (COM1-COM15 is possible).
- Start "**Scan probes**" in PICOConfig.
- The PICO probe logs in the window „**Probe List**“ after max. 30 seconds with its serial number.

NOTE 1:

In the Device-Manager passes it as follows:

Control Panel → System → Hardware → Device-Manager

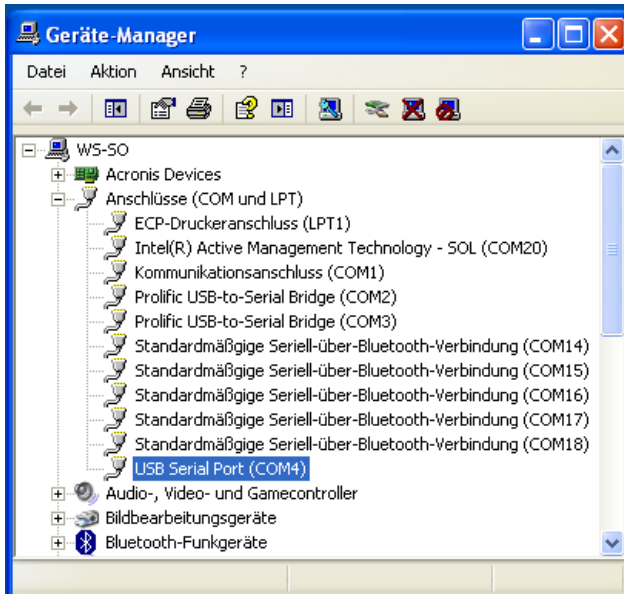

Under the entry "Ports (COM & LPT)" now the item "USB Serial Port (COMx)" is found.

COMx set must be between COM1....COM9 and it should be ensured that there is no double occupancy of the interfaces.

If it comes to conflicts among the serial port or the USB-SM has been found in a higher COM-port, the COM port number can be adjusted manually:

By double clicking on "USB Serial Port" you can go into the properties menu, where you see "connection settings" – with "Advanced" button, the COM port number can be switched to a free number.

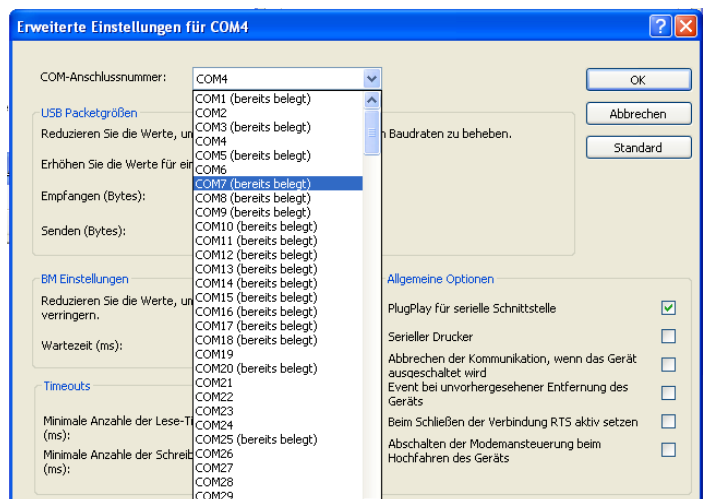
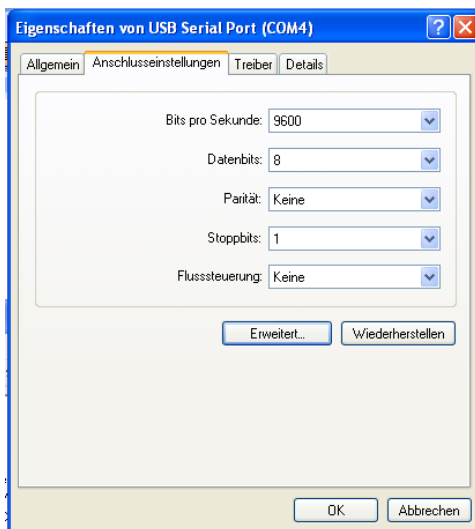

After changing the COMx port settings, PICO-CONFIG must be restarted.

11.2 RS485 or IMP-Bus Configuration and Probe Scan

With PICO-CONFIG it is possible to make process-related adjustments of individual parameters of the PICO probe. Furthermore, the measurement values of the PICO probe can be read from the probe via the RS485 or IMP-Bus interface and displayed on the screen.

In the menu "Bus" and the window "Configuration" the PC can be configured to an available COMx-port with the Baudrate of 9600 Baud.

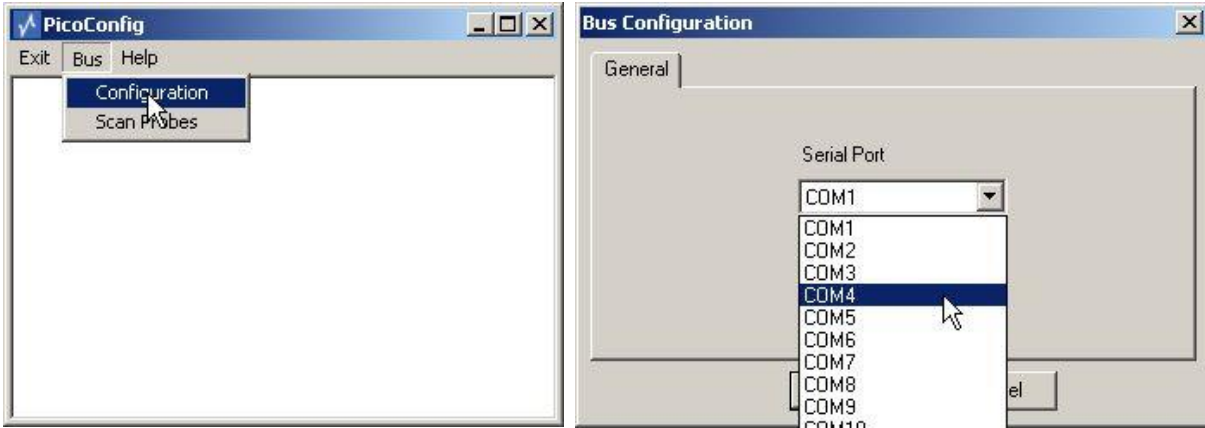

11.3 Scan of connected PICO probes on the RS485 or IMP-Bus

In the menu "Bus" and the window "Scan Probes" the RS485 bus can be scanned for attached PICO probes (takes max. 30 seconds).

PICO-CONFIG reports founded PICO probes with its serial number in the window "Probe List".

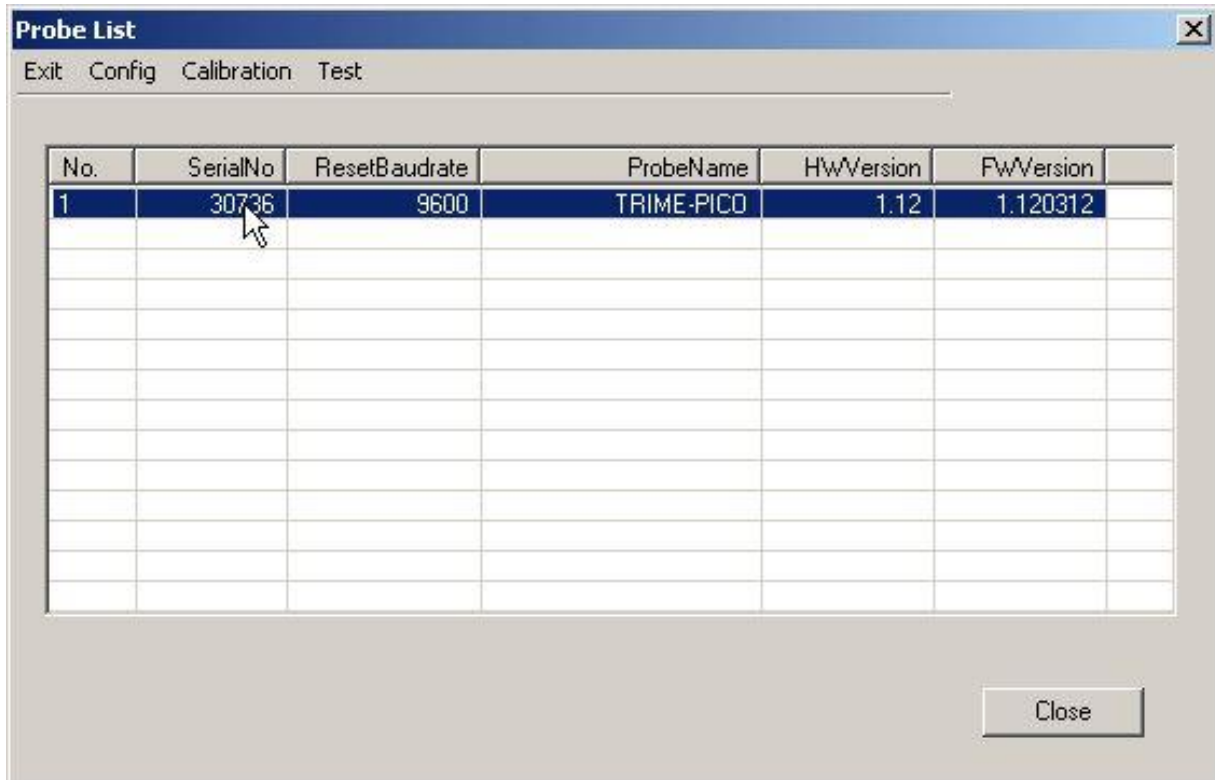

11.4 Configuration of Measure Mode

In "Probe List" with "Config" and "Measure Mode & Parameters" the PICO probe can be adjusted to the desired mode A, B or C (see Chapter "Configuration Measure Mode").

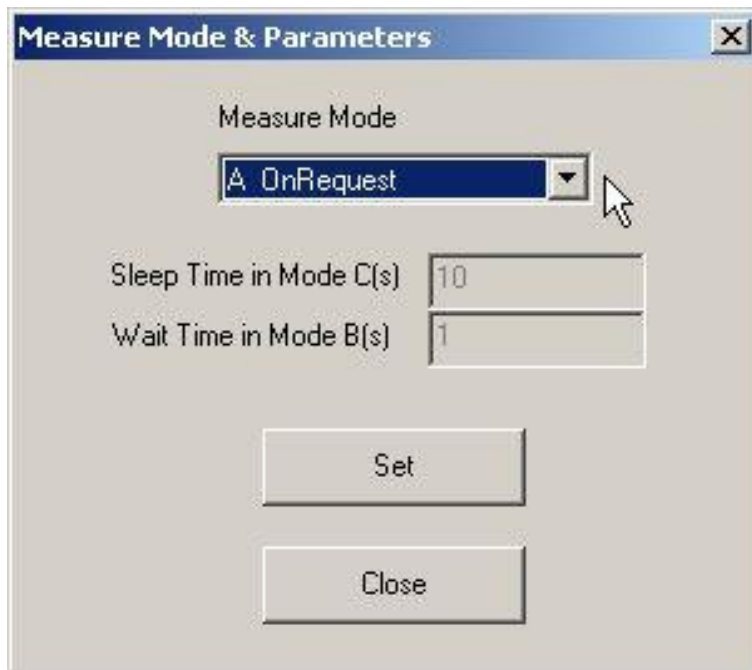

11.5 Analogue outputs of the PICO probe

In the menu "Config" and the window "Analog Output" the analogue outputs of the PICO probe can be configured (see Chapter "Analogue outputs").

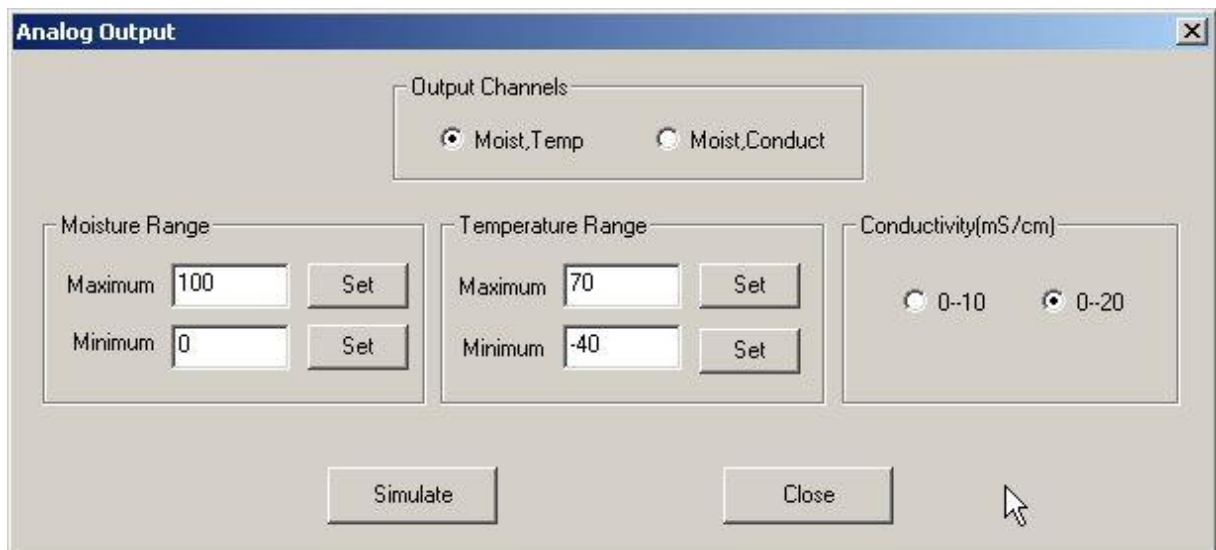

The conductivity range can be selected, depending on the specific soil which is measured. 0..20 dS/m should be selected for soils with a very high salinity content.

11.6 Simulate Analog Output

By pressing the button "Simulate" in the window "Analog Output" the analog output 1 and 2 can be simulated in 5 ranges from 0 to 100%. The %-value can be entered directly by hand and the analog output follows by pressing the button "Set".

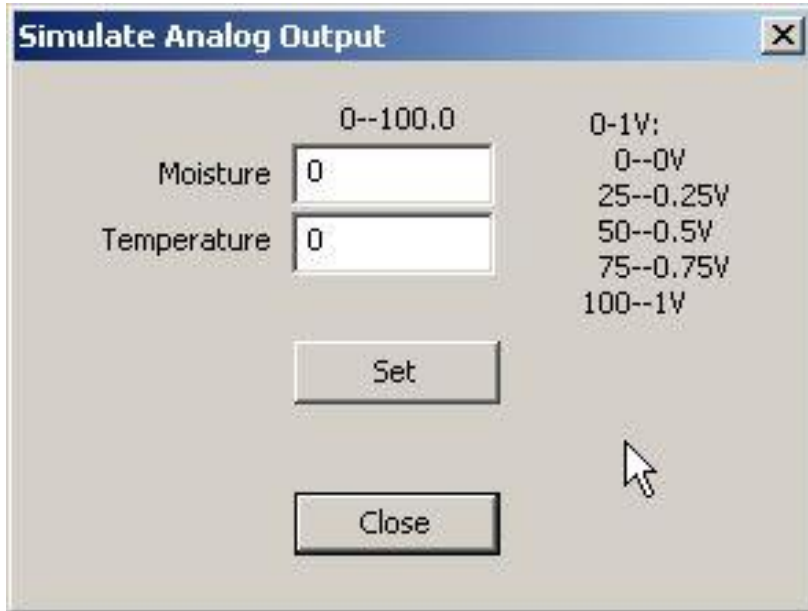

11.7 Selection of the individual Calibration Curves

In the menu "Calibration" and the window "Material Property Calibration" the calibration curves CAL1 to Cal15 which are stored in the PICO probe are loaded and displayed on the screen (takes max. 1 minute). With the mouse pointer individual calibration curves can be activated and tested with the PICO probe by activating the button "Set Active Calib". Furthermore, the individual calibration curves CAL1 to Cal15 can be adapted or modified with the calibration coefficients (see Chapter "Creating a linear calibration curve").

Cal	Act	=?	CalID-P	CalID-F	CalName in Probe	CalName in File	MatID-P	MatID-F	TemID-P	TemID-F	DerID-P	DerID-F
0			00000	00000	No Calibration		00000	00000	00000	00000	00000	00000
1	A		02002	00000	Universal Soil/Vol		02001	00000	02000	00000	02000	00000
2			02004	00000	Uni-Soil,dr.gr.,D=1.0...		02001	00000	02000	00000	02001	00000
3			02005	00000	Uni-Soil,dr.gr.,D=1.2...		02001	00000	02000	00000	02002	00000
4			02006	00000	Uni-Soil,dr.gr.,D=1.4...		02001	00000	02000	00000	02003	00000
5			02007	00000	Uni-Soil,dr.gr.,D=1.6...		02001	00000	02000	00000	02004	00000
6			02008	00000	Uni-Soil,dr.gr.,D=1.8...		02001	00000	02000	00000	02005	00000
7			02009	00000	Uni-Soil,dr.gr.,D=2.0...		02001	00000	02000	00000	02006	00000
8			02010	00000	Uni-Soil,dr.gr.,D=2.2...		02001	00000	02000	00000	02007	00000
9			02011	00000	Uni-Soil,dr.gr.,D=2.4...		02001	00000	02000	00000	02008	00000
10			02012	00000	Uni-Soil,dr.gr.,D=2.6...		02001	00000	02000	00000	02009	00000
11			02013	00000	Uni-Soil,dr.gr.,D=2.8...		02001	00000	02000	00000	02010	00000
12			02014	00000	Uni-Soil,dr.gr.,D=3.0...		02001	00000	02000	00000	02011	00000
13			02001	00000	Pseudo-time tp(ps)		02000	00000	02000	00000	02000	00000
14			02001	00000	Pseudo-time tp(ps)		02000	00000	02000	00000	02000	00000
15			02000	00000	No Calibration		02000	00000	02000	00000	02000	00000

Coefficients	Mat in Probe	Mat in File	Tem in Probe	Tem in File	Den in Probe	Den in File
m0,t0,d0	-3.013365e+001	0.000000e+000	2.000000e+001	0.000000e+000	0.000000e+000	0.000000e+000
m1,t1,d1	5.256210e-001	0.000000e+000	0.000000e+000	0.000000e+000	1.000000e+000	0.000000e+000
m2,t2,d2	-3.209332e-003	0.000000e+000	0.000000e+000	0.000000e+000	0.000000e+000	0.000000e+000
m3,t3,d3	9.810338e-006	0.000000e+000	0.000000e+000	0.000000e+000	0.000000e+000	0.000000e+000
m4,t4,d4	-1.362530e-008	0.000000e+000	0.000000e+000	0.000000e+000	0.000000e+000	0.000000e+000
m5,t5,d5	7.164000e-012	0.000000e+000	1.000000e+002	0.000000e+000	0.000000e+000	0.000000e+000

Calibration Item

Set Active Calib

Default Calibration Item

1

Set Default Calib

Coefficient Correction

CalName: Universal Soil,1

m0-m5: -30.1336

t0-t5: 20

Set

Close

The desired and possibly altered calibration curve (Cal1. .15) which is activated after switching on the probes power supply can be adjusted with the button "**Set Default Calib**".

The coefficients $m_1 = 0.0581$ and $m_0 = -4.05$ for individual calibration curves can be entered and adjusted directly by hand and are stored in the probe by pressing the "**Set**" button.

11.8 Test Run in Measurement Mode A

In the menu "**Test**" and the window **Test in Mode A**, the measured moisture values "**Moist**" of the PICO probe are displayed on the screen and can be parallel saved in a file.

Attention:

For a test run in mode A it must be ensured that the PICO probe was also set to this mode. If this is not assured, the probe returns zero values.

No.	Time	Date	Count	ASICCount	ASICTemp	t	tp	StdMst	MatMst	Moist	TDRLevel	MatTemp	Conduct
1	16:32:23	21.10.2010	847.546	847.546	51.10	1423.848	-28.608	-20.000	-42.010	0.000	98.300	23.0	0.000
2	16:32:18	21.10.2010	704.333	704.333	50.51	1183.255	-87.057	-20.000	-42.010	0.000	76.200	23.1	1.920
3	16:32:14	21.10.2010	1751.584	1751.584	49.98	2942.603	340.353	340.3...	13.663	13.660	83.900	23.0	0.920
4	16:32:09	21.10.2010	1665.059	1665.059	49.63	2797.243	305.039	305.0...	10.980	10.980	82.900	23.0	1.050
5	16:32:05	21.10.2010	993.675	993.675	49.10	1669.341	31.031	31.031	-16.633	0.000	82.900	23.0	1.050
6	16:32:01	21.10.2010	833.801	833.801	48.80	1400.757	-34.218	-20.000	-42.010	0.000	73.900	23.0	2.220
7	16:31:56	21.10.2010	1972.834	1972.834	48.56	3314.294	430.650	430.6...	22.028	22.020	86.900	23.0	0.530
8	16:31:52	21.10.2010	1989.098	1989.098	47.73	3341.618	437.288	437.2...	22.685	22.680	87.400	23.0	0.460
9	16:31:47	21.10.2010	1998.478	1998.478	46.65	3357.376	441.116	441.1...	23.064	23.060	87.400	23.1	0.460
10	16:31:43	21.10.2010	1488.004	1488.004	45.04	2499.797	232.779	232.7...	6.951	6.950	97.100	23.2	0.000

Following measurement values are displayed on the screen:

- Moist** Moisture Value
- MatTemp** Temperature
- Conduct** Bulk Electrical Conductivity EC_{TRIME}
- TDRLevel** TDR-Level (for special applications)
- tp** Radar time which corresponds to the respective moisture value.

The other values like Count, ASICCount, etc. are for special use.

By clicking „**Save**“ the recorded data is saved in a text file in the following path:

\PICO-CONFIG.exe-Pfad\MD\Dateiname

The name of the text file **TestMeas+SN+yyyymmddHHMMSS.sts** is assigned automatically with the serial number of the probe (SN) and date and time.

The data in the text file can be evaluated with Windows-EXCEL.

Basic Balancing in Glass Beads

PICO probes are identical and manufactured precisely. After an exchange of a probe rod it is nevertheless advisable to verify the calibration and to check the basic calibration and if necessary, to correct it with a "Basic Balancing".

With a "Basic Balancing" two reference calibration measurements are to be carried out with known set-points ("RefValues"). For the reference media, dry and wet glass beads should be used.

Attention:

Before performing a "Basic Balancing" it must be ensured that the PICO probe was set to "Measure Mode" A. If this is not assured, the probe returns zero values. After a "Basic Balancing" the PICO probe has to be set to "Measure Mode" B or C again.

In the menu "**Calibration**" and the window "**Basic Balancing**" the two set-point values of the radar time **tp** are displayed with 145ps and 625ps.

Reference set-point A: **tp**=145ps in dry glass beads.

The first set-point can be activated with the mouse pointer by clicking to No.1. By activating the button "**Do Measurement**" the PICO probe determines the first reference set-point in dry glass beads. In the column „MeasValues“ the measured raw value of the radar time **t** is displayed.

Reference set-point B: **tp**=625ps in wet glass beads. The PICO probe head has to be completely covered with wet glass beads. The second set-point can be activated with the mouse pointer by clicking to No.2. By activating the button "**Do Measurement**" the PICO probe determines the second reference set-point in wet glass beads. In the column „MeasValues“ the measured raw value of the radar time **t** is also displayed.

By activating the button „**Calculate Coeffs**“ and „**Coeffs → Probe**“ the alignment data is calculated automatically and is stored in the PICO probe non-volatile. With a "Test run" (in Mode A) the radar time **tp** of the PICO probe should be now 145ps in dry and 625ps in wet glass beads.

No	RefValues(tp)/ps	MoistValues(%)	MeasValues(t)/ps	Comments
1	145.0	2.8		dry glass bead
2	625.0	43.9		wet glass bead

Coefficients	<Calculated>	<in File>	<in Probe>
b0			-374.513
b1			0.242937

dry,wet glass bead

Do Measurement

Calculate Coeffs

Coeffs -> Probe

Close

11.9 TRIME WIN MONITOR Datalogger Software

TRIME WIN MONITOR is a datalogger software for measurement data collection of TRIME sensors. TRIME WIN MONITOR runs under Windows.

The software and the manual can be downloaded from IMKO's homepage under the menu item "Support", "Software" and "TRIME WIN MONITOR".

11.10 Calibration Curves

PICO64/32 probes are supplied with different calibration curves.

Cal1 Universal Soil Vol. is a nonlinear calibration curve 5th order which is suitable for most soils.

Cal 2 to Cal7 (see next pages) can be selected for special applications.

These are the calibration functions installed to the upgrade version of the Trime-PICO32/64 delivered together with the measurement of the Radar based Conductivity (RbC). If you want to have these Calibration functions for your current Trime-PICO please contact IMKO GmbH (info@imko.de)

A maximum of 15 different calibration curves (Cal1 ... Cal15) can be stored inside the PICO probe and can optionally be activated via the program **PICO-CONFIG**.

A preliminary test of an appropriate calibration curve (Cal1. .15) can be activated in the menu "**Calibration**" and in the window "**Material Property Calibration**" by selecting the desired calibration curve (Cal1...Cal15) and with using the button "**Set Active Calib**".

The finally desired and possibly altered calibration curve (Cal1. .15) which is activated after switching on the probes power supply will be adjusted with the button "**Set Default Calib**".

Nonlinear calibrations are possible with polynomials up to 5th grade (coefficients m0 to m5).

IMKO publish on its website more suitable calibration coefficients for different materials. These calibration coefficients can be entered and stored in the PICO probe by hand (Cal14 and Cal15) with the help of PICO-CONFIG.

Next page:

The following charts (Cal.1 .. 15) show different selectable calibration curves which are stored inside the PICO probe.

On the y-axis the gravimetric moisture **Moist** (or **Dielectric-Constant Epsilon**) is shown. On the x-axis depending on the calibration curve the associated radar time **tp** in picoseconds is shown. With the software **PICO-CONFIG** the radar time **tp** is shown on the screen parallel to the moisture value **Moist**.

Calibration functions Trime-PICO64

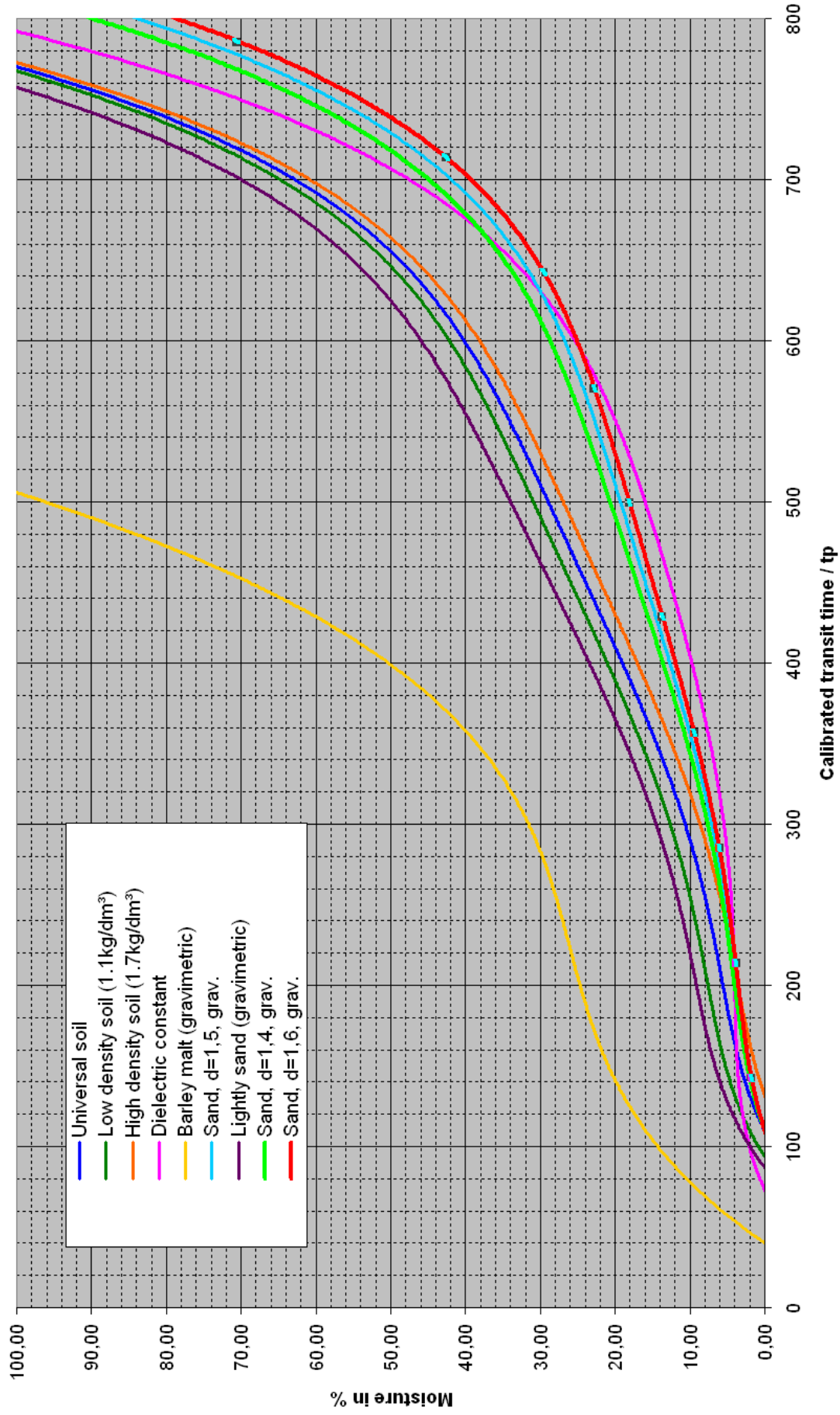

Calibration functions Trime-PICO32

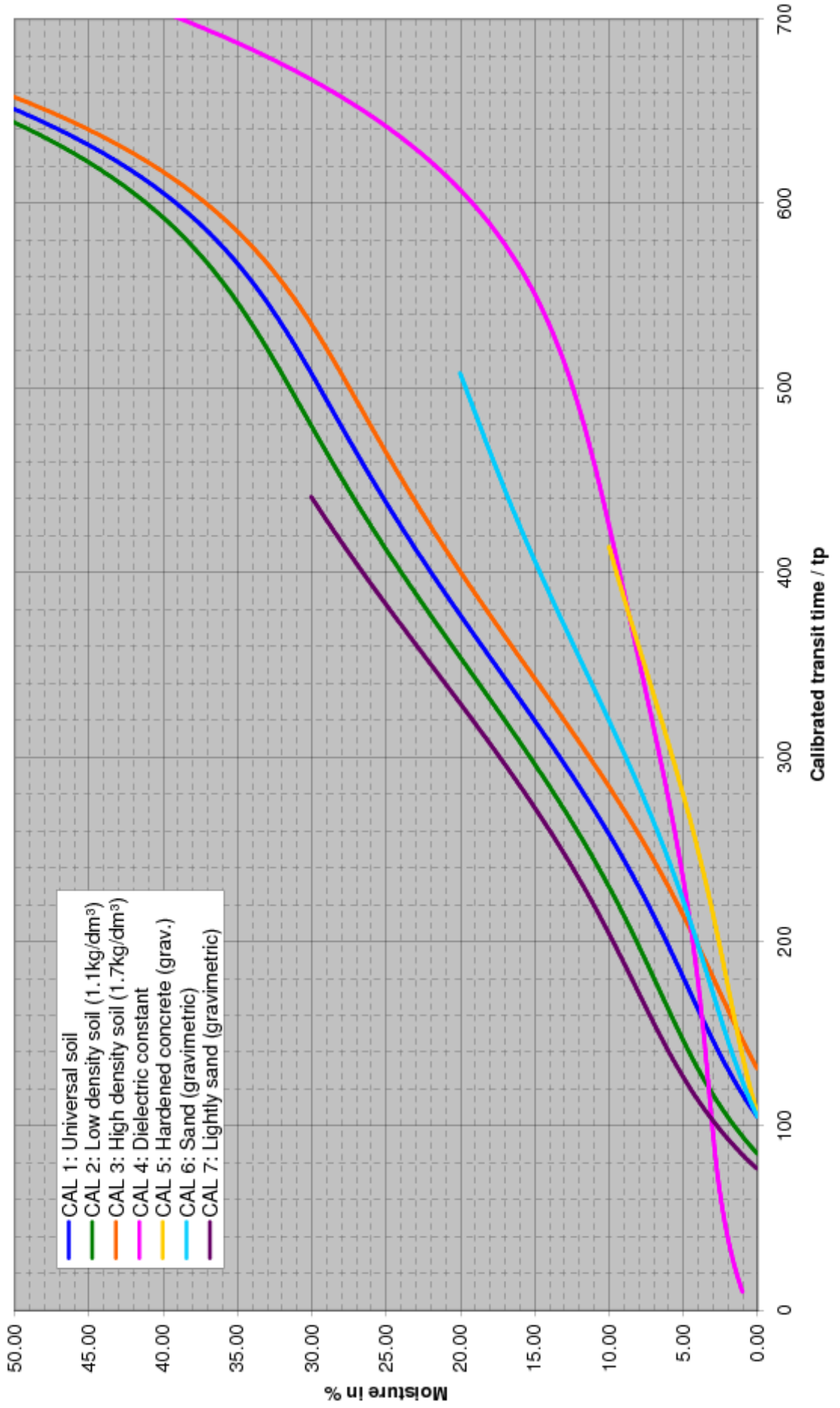

11.11 Creating a linear Calibration Curve for a specific Material

The calibration curves Cal1 to Cal15 can be easily created or adapted for a specific soil with the help of PICO-CONFIG. Therefore, two measurement points need to be identified with the probe. Point P1 at dried soil and point P2 at moist soil where the points P1 and P2 should be far enough apart to get a best possible calibration curve.

The moisture content of the soil at point P1 and P2 can be determined with laboratory measurement methods (oven drying). It is to consider that sufficient material is measured to get a representative value.

Under the menu "**Calibration**" and the window "**Material Property Calibration**" the calibration curves CAL1 to Cal15 which are stored in the PICO probe are loaded and displayed on the screen (takes max. 1 minute). With the mouse pointer individual calibration curves can be tested with the PICO-probe by activating the button "**Set Active Calib**". The measurement of the moisture value **Moist** with the associated radar time **tp** at point P1 and P2 is started using the program PICO-CONFIG in the sub menu "**Test**" and "**Test in Mode A**".

Step 1: The radar pulse time **tp** of the probe is measured with dried soil. It is recommended to detect multiple measurement values for finding a best average value for **tp**. The result is the first calibration point P1 (e.g. 70/0). I.e. 70ps (picoseconds) of the radar pulse time **tp** corresponds to 0% moisture content of the material.

But it would be also possible to use a higher point P1' (e.g. 190/7) where a **tp** of 190ps corresponds to a moisture content of 7%. The gravimetric or volumetric moisture content of the material, e.g. 7% has to be determined with laboratory measurement methods (oven drying).

Step 2: The radar pulse time **tp** of the probe is measured with moist material. Again, it is recommended to detect multiple measurement values of **tp** for finding a best average value.

The result is the second calibration point P2 with X2/Y2 (e.g. 500/25). I.e. **tp** of 500ps corresponds to 25% moisture content. The gravimetric or volumetric moisture content of the material, e.g. 25% has to be determined with laboratory measurement methods (oven drying).

Step 3: With the two calibration points P1 and P2, the calibration coefficients m_0 and m_1 can be determined for the specific soil (see next page).

Step 4: The coefficients $m_1 = 0.0581$ and $m_0 = -4.05$ (see next page) for the calibration curve Cal15 can be entered directly by hand and are stored in the probe by pressing the button "**Set**".

The name of the calibration curve can also be entered by hand. The selected calibration curve (e.g. Cal15) which is activated after switching on the probes power supply will be adjusted with the button "**Set Default Calib**".

Attention:

Use "dot" as separator (0.0581), not comma!

11.12 Calculation for a linear 2-point calibration curve

1. Download the Excel-Sheet „**SONO 2-Point LinearCalibration_Calculation**“ from IMKO's Homepage under „Support Software“.
2. Enter into the Excel-Sheet both TP-values with the respective reference moisture values.
3. Read out both parameters m_0 and m_1 from the Excel-Sheet.
4. Enter, set and save both parameters m_0 and m_1 with help of the software „SONO-CONFIG“ in the menu „**Calibration**“ in the window „**Material Property Calibration**“ in the selected calibration curve.

11.13 Calculation for a non-linear calibration curve

PICO probes can work also with non-linear calibration curves with polynomials up to 5th grade.

For a non-linear calibration it is necessary to calibrate with 4...8 different calibration points with different T_p values and the related moisture values in %. To calculate nonlinear coefficients for polynomials up to 5th grade, an EXCEL software tool from IMKO can be used.

1. Download the Excel-Sheet „SONO_NonlinearCalibration_Calculation“ from IMKO’s Homepage under „Support Software“.
2. Enter the T_p -values with the respective reference moisture values into the Excel-Sheet.
3. Read out the parameters m_0 to m_5 from the Excel-Sheet.
4. Enter, set and save the parameters m_0 to m_5 in the selected calibration curve with help of the software „SONO-CONFIG“ in the menu „Calibration“ under the window „Material Property Calibration“.

The following diagram shows a sample calculation for a linear calibration curve with the coefficients m_0 and m_1 for a specific soil or material.

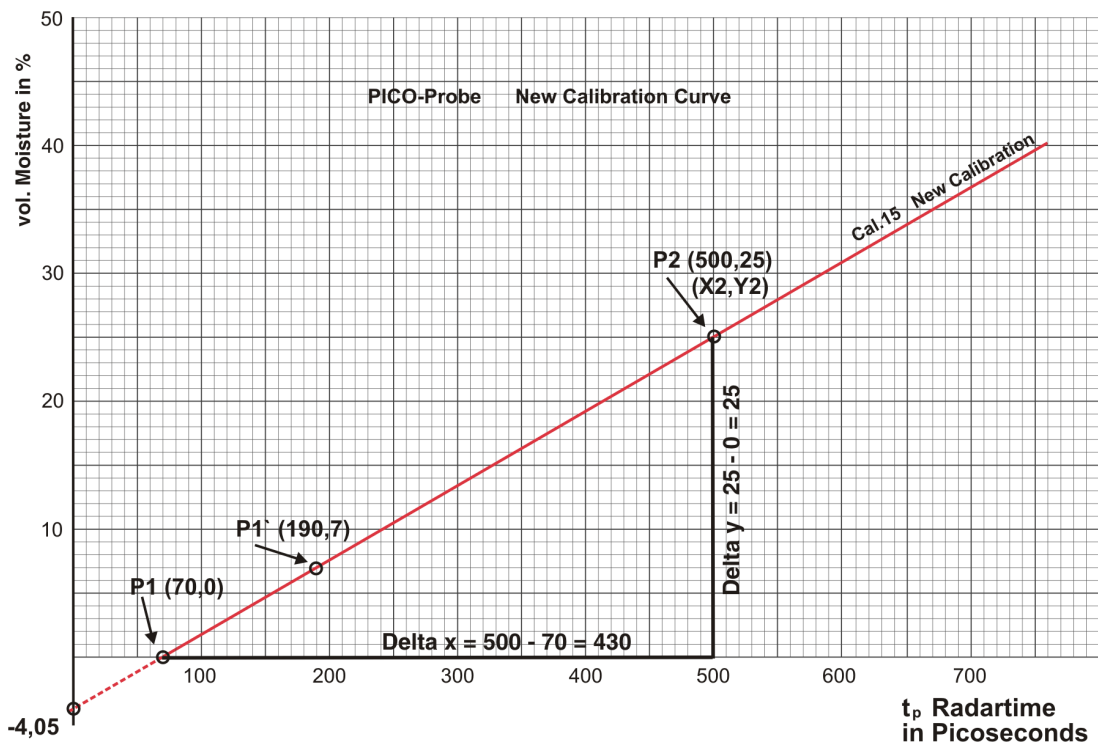

The coefficient m_1 is calculated from the slope of the curve Cal15:

$$\text{Coefficient } m_1 = \frac{\text{Delta } y}{\text{Delta } x} = \frac{25 - 0}{500 - 70} = 0,0581$$

The coefficient m_0 is the offset on the y-axis at $x = 0$:

$$\text{Coefficient } m_0 = Y_2 - (m_1 * X_2) = 25 - (0,0581 * 500) = -4,05$$

12 Measure Electrical Conductivity with TRIME Probes

A reliable, practical and easy-to-use Determination of Soil Conductivity and Salt Content with TRIME Probes

IMKO's TRIME TDR-probes can now report soil EC as standard simultaneously with soil moisture content percentage. A manual conversion based on researched curves for different soil types enables the user to derive a soil EC expressed in mg/l TDS (total dissolved salts).

TRIME TDR probes can do this very accurately because:

TRIME probes measure conductivity with the same large soil volume as it will be used for the TDR moisture measurement. The contact of the probe rods inside the soil is far less critical as with "galvanic" EC probes with a point to point measurement where even small air gaps lead to significant deviations.

TRIME probes use coated and therefore isolated rods which guarantee the non-appearance of galvanic accumulation along the rods allowing for long-run installations over many years. Unisolated rods means there is a risk of galvanic reactions and possible influence on the sensor's reading with serious problems when the probes must be removed from larger depths due to a rod cleaning.

TRIME probes measure moisture and conductivity very precisely at a frequency of 1GHz with a better and more exact separation of moisture and conductivity in comparison to capacitive probes with lower frequencies. This means that in practice, a reliable determination of the pore water conductivity EC_w and respectively TDS (mg of salt per liter water) is possible at different moisture levels.

All TRIME probes work with a concurrently basic calibration for moisture and conductivity. This allows a check of the limits of saline stress in soils according to standards of FAO2006 for specific soils.



12.1 The analysis of Soils for Electrical Conductivity ECTRIME

NOTE:

The analysis of electrical conductivity is an immensely complex subject. This resume is not intended as a study document in soil science nor does it discuss the technical complexities of the devices used.

For agricultural and horticultural soils, the measurement of Electrical Conductivity is an immensely important measurement. Electrical Conductivity measures the amount of total dissolved salts (TDS) or total dissolved ions in water. To complicate matters, some ions such as Sodium and Chloride will contribute more to EC than others such as Phosphorus and Potassium.

Plants require nutrients such as Nitrogen, Phosphorus, Potassium, Magnesium in large quantities hence they are called major nutrients and also smaller amounts of elements such as Iron, Manganese, Molybdenum and these are called micro nutrients or sometimes referred to as trace metals.

Fertilisers are supplied to plants as compounds for example Ammonium Nitrate which supplies Nitrogen in the form of Nitrate or Ammonium. Micro-organisms will break down these compounds, so they are more readily available for uptake by the plants. Levels of some ions such as Chlorides are less desirable and in great quantities can be harmful to plant growth. The quantity of ions or salts in a soil is of huge importance. Too much or too few nutrients will create a restriction in plant growth.

Measurement of EC in water is relatively straightforward. An EC probe (usually platinum) is inserted in the water and a reading in mS/cm is reported on the meter's display. This is relatively easy because water is a homogenous medium. Soil on the other hand is not and this has caused great difficulties when trying to measure its conductivity. To work around this, the analysis on agricultural and horticultural soils has been carried out by mixing a volume of soil and a volume of water and measuring the EC on the suspension or filtered extract.

Different countries and different regulatory bodies have specified methodologies and in general results have been good enough to use for fertilisation recommendations and programmes. This analysis was generally carried out by a laboratory and whereas results were and are reliable the method is slow, time consuming and expensive.

Over the years manufacturers have tried to come up with solutions whereby an instrument could be used directly in soils without having to resort to laboratories. The EC reported by these instruments is referred to soil bulk electrical conductivity. Whereas there has been some success, there are so many influential variables such as temperature, soil moisture and granular composition that results have not been adequate for reliable fertilisation studies. Mostly soil bulk conductivity was of academic rather than practical interest.

IMKO has studied the subject in detail and has come up with a breakthrough. By using coated rods and measuring over the length of the probes, all TRIME probes can now accurately report what IMKO calls EC_{TRIME} . This measurement takes account of soil moisture and conductivity by volume.

Because soil moisture is so important in the calculation of EC, all different TRIME probes now incorporate TDR calibration curves for a selection of soils. Special graphs have been constructed so that the user can convert the EC_{TRIME} reading to grams/litre of dissolved salt. So far curves are available for sandy and loam soils and it is intended to produce a handful of curves to cover most situations. At this moment in time, conversion of EC_{TRIME} to mg/l TDS is done manually.

IMKO hopes that this breakthrough whereby a TDR instrument can be used to derive a true soil EC measurement will become the new standard for soil fertilisation analyses.

12.2 ECTRIME Measurement Range for TRIME Probes

All PICO probes work with a concurrently basic calibration for moisture and conductivity. This allows a check of the limits of saline soils according to standards of FAO2006 for specific soils.

Measurement Range Conductivity for PICO64, PICO32, T3-IPH, PICO-PROFILE 0...10dS/m EC_{TRIME} (here is, depending on moisture content $EC_w > 20dS/m$)

All TRIME probes have a linear EC_{TRIME} calibration curve with two calibration points. This ensures an equal behaviour of a TRIME probe type (e.g. PICO32).

Calibration Point1: Dry glass beads = 0dS/m EC_{TRIME}

Calibration Point2: Saturated glass beads with water EC_w 5dS/m = 5dS/m EC_{TRIME}

With dry glass beads (not air!) it is ensured that the conductivity range of dry soils starts with nearly 0dS/m. The calibration at point2 was performed with glass beads and water which was adjusted with salt to a pore water conductivity of $EC_w = 5dS/m$ at a temperature of 23°C.

12.3 Measurement of Pore-Water-Conductivity or Salt-Content of Soils

The possible salt stress depends on soil type and plant species and can be roughly classified:

Slight salinization:	1-3g of salt per liter
Average salinity:	3-5g salt / liter
Strong salinity:	5-10g salt / liter
Very high salinity:	> 10 g salt / liter

The conversion of the salt content in grams of salt per liter water (TDS Total-Dissolved-Salts) into the pore water conductivity of EC_w happens with:

$$\text{Salt content in grams of salt per liter of water TDS} = 0.64 * EC_w$$

An $EC_w = 5\text{mS/cm}$ result thus with 3.2 grams of salt per liter (pore) water

EC_w can be determined with a laboratory conductivity meter. $1\text{dS/m} = 1\text{mS/cm}$

A determination of the pore water conductivity or salinity of soils and sand at different moisture values is possible by using a Moisture/ EC_{TRIME} diagram for the PICO32 or PICO64. With measuring moisture and EC_{TRIME} , the pore water conductivity (or TDS salt content in grams salt per liter) of the soil can be determined by using the individual pore water water curves.

The below displayed Moisture/ EC_{TRIME} charts were created for sand and a loamy soil.

We recommend the creation of a separate Moisture/ EC_{TRIME} diagram for the intended soil in the designated ranges of salinity.

The following diagram illustrates curve progressions of pore-water with four different salinity contents at different moisture contents for the PICO32.

Sand1 was mixed with 0,5dS/m pore water, sand2 mixed with water which had a conductivity of 5dS/m, sand3 with 10dS/m and sand4 with 20dS/m water. The PICO32 determines different EC_{TRIME} conductivities in the different sands at one moisture level. The moisture range with the best resolution for the EC_{TRIME} measurement lies between 10% and 30%, depending on the salt content.

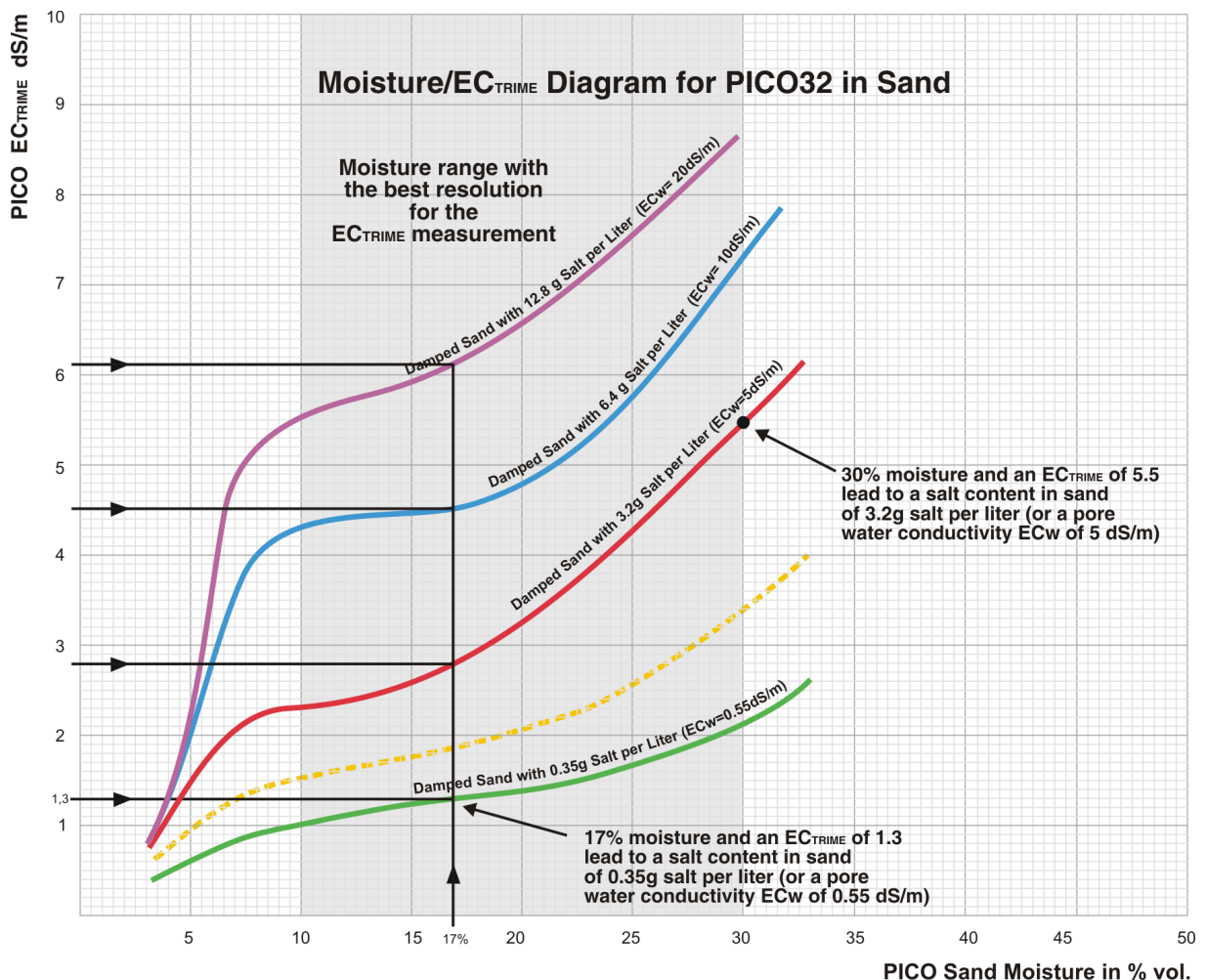

How to determine the salt content

With both parameters, the moisture value (X-axis) and EC_{TRIME} (Y-axis) it is possible to determine the salt content in sand. With a moisture content of e.g. 17% and an EC_{TRIME} of 4,6dS/m, the intersection point lies on the blue curve which represents a salt content of 6,4g salt per liter water in the sand.

With 30% moisture content and an EC_{TRIME} of 5,5dS/m the salt content would be 3,2g salt per liter water in the sand.

The intersection point of „Moisture“ and „ EC_{TRIME} “ is representing the salinity curve EC_w in the sand-diagram.

This sand diagram shows four pore water curves. If intersection points lies between this four curves (e.g. the yellow curve), the result of the salt content has to be interpolated.

The following diagram illustrates curve progressions of EC_{TRIME} for PICO32 for a loamy soil at different salt contents. The PICO32 determines different EC_{TRIME} conductivities in different soils at one moisture level. The moisture range with the best resolution for the EC_{TRIME} measurement for a loamy soil is between 25% and 35%.

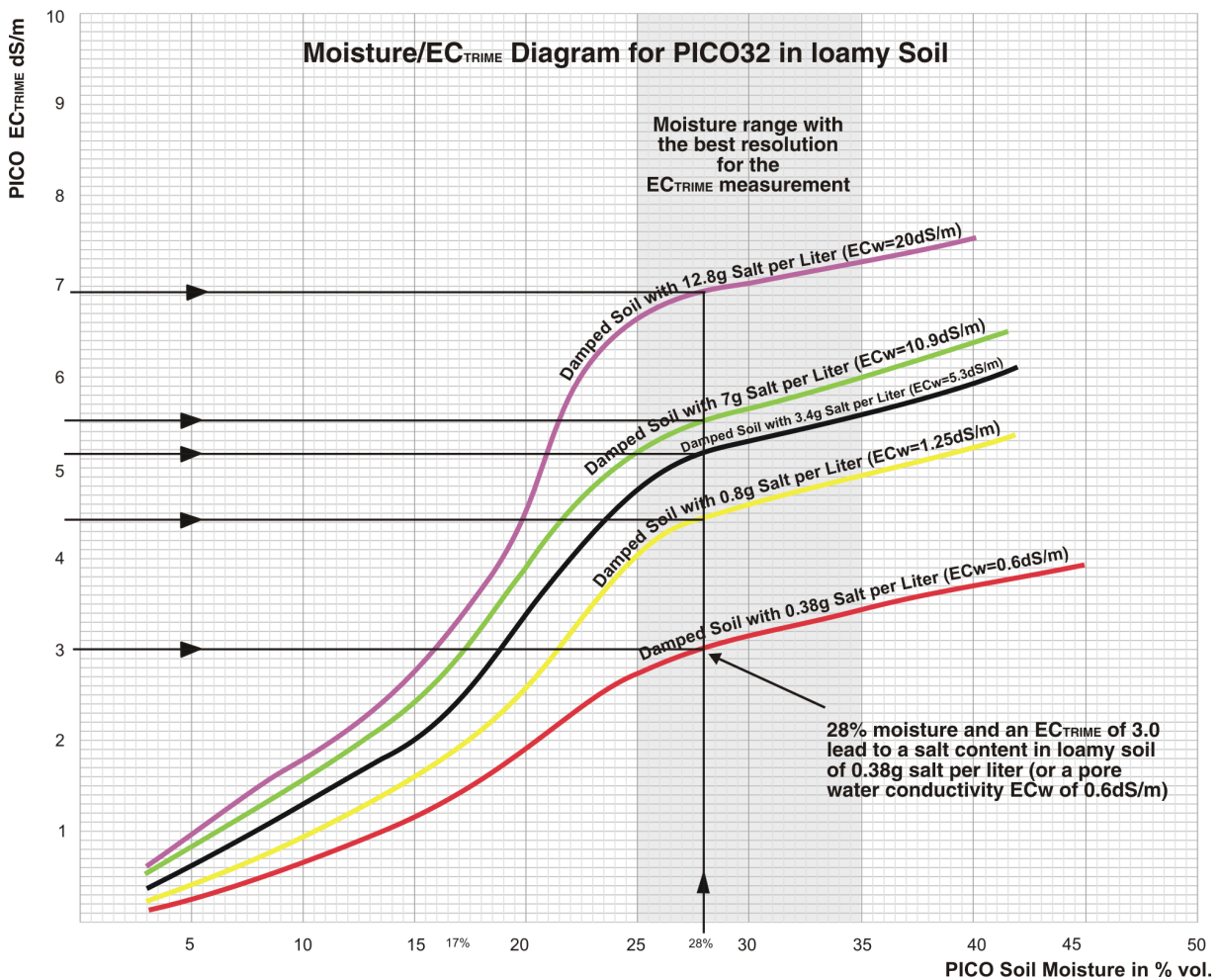

Also here the intersection point of „Moisture“ and „ EC_{TRIME} “ is representing the salinity curve EC_w in the soil-diagram.

12.4 Creation of a Moisture/ EC_{TRIME} Diagram for a particular Soil

The following description shows a possible way to create a Moisture/ EC_{TRIME} diagram for a particular soil:

Take a soil sample and determine the salt content with a laboratory method. (e.g. determine EC_w of the soil/water saturation extract).

Dry the soil sample to 0% moisture. Cut it into small pieces and grind the soil so that it can be moistened by hand as evenly as possible (eg with a water spray pump).

Moisten the soil evenly with a pore water solution for example 2.56g of salt per liter (equivalent to $EC_w=4dS/m$) to the first measurement point (e.g 2.5% moisture). Take into account, that the soil already contains salt. I.e. were already 1g of salt per liter in the soil, you put a curve for a pore water conductivity record of 2.56 g + 1g salt = 3.56g per liter ($EC_w=5.5 dS/m$).

Compact the soil in a plastic bowl (no metal and not too small!) so that it largely corresponds to the natural density. Concerning the insertion of the PICO-probe rods for measurement, it is recommended to perform several measurements per point in order to form an average value for each moisture and EC_{TRIME} value. It is important to ensure that the measuring field is not disturbed around the rods, eg by previous punctures.

Moisten the soil more, as homogeneous as possible with the pore water solution $EC_w=4dS/m$ to eg 5% moisture. Again, compact the soil in a plastic bowl so that it largely corresponds to the natural density. Concerning the insertion of the PICO-probe rods for measurement, it is recommended to perform several measurements per point in order to form an average value for each moisture and EC_{TRIME} value. It is important to ensure that the measuring field is not disturbed around the rods, eg by previous punctures.

Take more moisture and EC_{TRIME} values, up to soil saturation.

Create the pore-water curve for example for 3.56g salt/liter ($EC_w=5.5dS/m$) with the added moisture and EC_{TRIME} values. Take up several curves for different pore water contents.

If the soil sample is already too heavily loaded with salt, a washing out of the ions would be possible, but without the lost of the fine fraction. After a subsequent drying and crushing of the soil, the Moisture/ EC_{TRIME} diagram can be established with a lower salt content. It is also possible to use distilled water for obtaining the lowest curve.

NOTE:

The effort for a Moisture/ EC_{TRIME} diagram is not negligible. IMKO has the hope to establish with the EC_{TRIME} process an easier, faster, better and generally accepted determination of the salt contamination of soils. In future IMKO plans to provide or publish different Moisture/ EC_{TRIME} curves for standard soils. We expect to cover nearly most soils with about 4-5 diagrams.

13 Software Error codes

13.1 Software Errors which will be coded with 4 igits.

Code	Explanation	Measurement
0101-0108, 0301	Serial Port errors	Check port's setting or if the port has been opened. Then close and restart the program.
0201	No answer	Check the power of PICO, the serial port of PC and the connection between PC and PICO.
0202-0212	Protocol errors	Check if PICO-CONFIG's version passes PICO's version.
0302-0307	Protocol error, Parameter setting false	Check if parameters are correct and if PICO-CONFIG's version passes PICO's version.
0401	Can not find config file PICO-CONFIG.con	Look for the file in the exe path. If not found, copy the file to the path.
0501-0508	Errors in Event & MeasureMode	Restart PICO and PICO-CONFIG
0601,0602,0604, 0605,0606,0607, 0609	Operation errors in Basic Balancing	Operate correctly and try it again.
0603,0608,0610, 0611	Communication or protocol errors in Basic Balancing	Restart PICO and PICO-CONFIG.
0701,0702	Read file errors in Material Property Calibration	Check if the files are in the required path. If not, copy the files to the path or redefine the path under the menu Bus/Configuration/Material Property Calibration.
0703	Operation errors in Material Property Calibration	Operate correctly and try it again.
0704, 0705,0706	Communication or protocol errors in Material Property Calibration	Restart PICO and PICO-CONFIG.
0801-0805,0901	Operation errors in Calibration IDs and Names	Operate correctly and try it again.
1001,1101,1102	Read file errors in Calibration IDs and Names	Check if the files are in the required path. If not, copy the files to the path or redefine the path under the menu Bus/Configuration/Material Property Calibration.
1201, 1203	Operation errors in Test	Operate correctly and try it again.
1202	Communication or protocol errors in Test	Restart PICO and PICO-CONFIG.
1301	Write file error in Test	Check file path and try it again. If failed, restart PICO-CONFIG.
4001-4002, 4101-4106,4201	Read file or write file errors	Check the files and try again.
4301-4303	Intenal calculating errors	Restart PICO-CONFIG and try again. Otherwise contact IMKO.

13.2 PICO Errors (Firmware errors). The errors come from the firmware, from 1 to 255.

Code	Explanation	Measurement
1-19	The serial communication errors due to incorrect telegram, baud rate, timing etc.	Power off, power on PICO and try it again. Otherwise contact IMKO.
20-39	incorrect command number, command right or command parameters.	Power off, power on PICO and try it again. Otherwise contact IMKO.
40-49	EEPROM is defect	Power off, power on PICO and try it again. Otherwise contact IMKO.
50-59	ASIC is defect	Power off, power on PICO and try it again. Otherwise contact IMKO.
60	Power voltage is too low	Check power voltage of PICO, it is minimal 6V.
100	TDR measurement parameter is incorrectly set or the material conductivity is too high.	Adjust the TDR measurement parameters or contact IMKO
101	TDR measurement parameter is incorrectly set	Adjust the TDR measurement parameters or contact IMKO
102	ASIC is defect	Power off, power on PICO and try it again. Otherwise contact IMKO.
103	EC parameter is incorrectly set.	Power off, power on PICO and try it again. Otherwise contact IMKO.
105	TP is out of range for the standard calibration polynomial.	Check if PICO is inserted in the measured material correctly.
108	TDR measurement parameter is incorrectly set or the material conductivity is too high.	Adjust the TDR measurement parameters or contact IMKO
120-129	Internal chip problem	Power off, power on PICO and try it again. Otherwise contact IMKO.
130-199	Internal errors	Contact IMKO
200-254	Reserved	
255	The data transmission is not finished.	

14 Safety Notes

In this documentation, text points are highlighted, which require special attention.



DANGER:

The Warning Triangle with the exclamation mark warns you against personal injury or property damage.

Intended Use

Sensors and measuring systems of IMKO GmbH may only be used for the purpose described, taking into account the technical data. Misuse and use of the equipment other than for its intended purpose are not eligible. The function and operational safety of a sensor or measuring system can only be guaranteed if the general safety precautions, national regulations and the special safety instructions in this operating manual are observed during use.

The moisture sensors and measuring systems of IMKO GmbH are used to measure moisture according to the measuring purpose and measuring range defined and defined in the technical data. Only adherence to the instructions described in the manual is regarded as intended use. The manual describes the connection, use and maintenance of IMKO sensors and IMKO measuring systems. Read the manual before connecting and operating a sensor or measuring system. The manual is part of the product and must be kept close to the sensor or measuring system.



Impairment of safety

The sensor or the measuring system has been designed and tested in accordance with EN 61010 safety regulations for electronic measuring instruments and has left the factory in a safe and safe condition. If the sensor or the measuring system can no longer be operated safely, it must be put out of operation and secured by means of marking before further commissioning. In case of doubt, the sensor or the measuring system must be sent to the manufacturer or his contractual partner for repair or maintenance.



Modifications

For safety reasons, it is not permitted to carry out any modifications or modifications to the sensor or the measuring system without the consent of the manufacturer. The opening of the sensor or hand-held meter, adjustment and repair work, as well as all maintenance work other than the work described in the manual may only be carried out by a specialist authorized by IMKO. The sensor or the measuring system must be disconnected from the power supply before installation or maintenance work. Do not open or repair the hand-held unit and the power supply!



Hazard Warnings

Danger due to improper operation. The sensor or the measuring system may only be operated by instructed personnel. The operating personnel must have read and understood the operating instructions.



Danger by electricity

The hand-held meter must not be immersed in water or other liquids. The sensor is insensitive to moisture contained in the typically measured products. Only connect the hand-held meter to a properly installed outlet with the supplied voltage supply cable, the voltage of which corresponds to the technical data. Make sure that the power outlet is well accessible, so that you can unplug the power supply quickly if necessary. Use only the adapter that is suitable for your outlet.

Only operate the meter with the supplied original accessories. If you need additional accessories or replacement, please contact the manufacturer.

Do not use the meter in following case:

- if the measuring instrument, sensor, plug-in power supply or accessories are damaged,
- the sensor or the measuring system does not operate as intended,
- the power cord or plug is damaged,
- the sensor or the measuring system has fallen down.

Unplug the power supply from the wall outlet in following case:

- if you do not use the sensor or the measuring system for an extended period of time,
- before cleaning, unpacking or changing the sensor or the measuring system,
- if you are working inside the sensor or measuring instrument, e.g. connect devices,
- if a fault occurs during operation,
- during thunderstorms.



Caution - Property damage

Ensure that there is a sufficient distance to strong heat sources such as heating plates, heating pipes. Disconnect the sensor or handheld device from other devices before relocating or transporting it. Disconnect the connectors on the device.

Do not use aggressive chemical cleaning agents, scouring agents, hard sponges or the like.

NOTES:

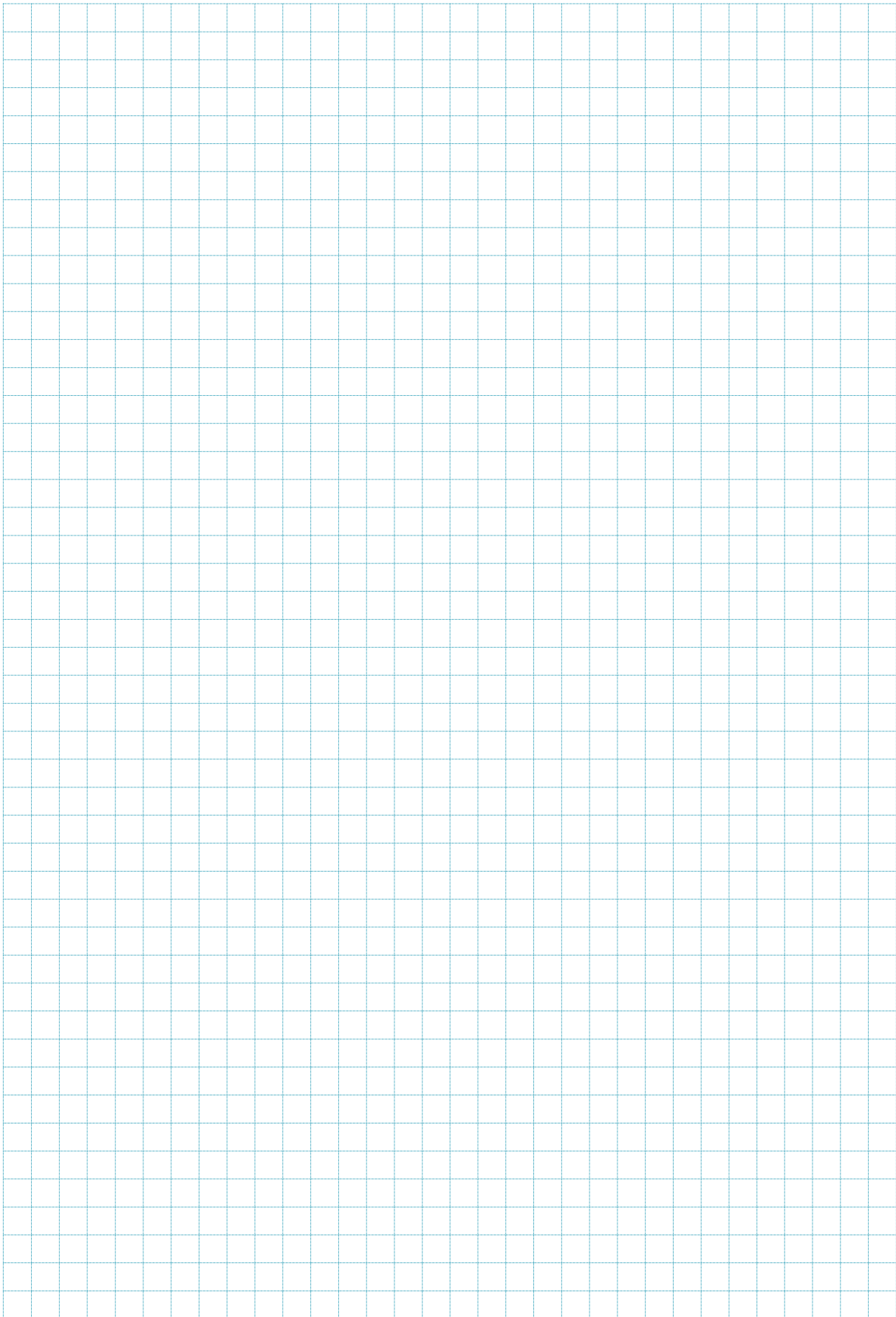

IMKO Micromodultechnik GmbH
Am Reutgraben 2
76275 Ettlingen
Germany

Phone: +49-7243-5921-0
Fax: +49-7243-5921-40
info@imko.de

www.imko.de

